

**EUROPEAN
WEED
RESEARCH
SOCIETY**

Abstracts

**4th EWRS Workshop on
Physical Weed Control**

**Elspeet, The Netherlands
20-22 March 2000**

**Compiled and produced by
*Daniel Cloutier***

February 18, 2002

Abstracts were compiled and produced by

**Daniel Cloutier
Institut de malherbologie
P.O. Box 222
Sainte-Anne-de-Bellevue
(Québec) H9X 3R9
Canada
(E-mail: daniel.cloutier@videotron.ca)**

Abstracts, addresses and further information about the physical weed control working-group are available on <http://www.ewrs.org/physical-control>

The workshop was organised and hosted by

Piet Bleeker

Rommie van der Weide

Practical research for arable farming and field production of vegetables
(PAV) P.O. Box 430, 8200 AK Lelystad, the Netherlands

P.Bleeker@pav.agro.nl

R.Y.van.der.Weide@pav.agro.nl

Dirk Kurstjens

Institute of Agricultural and Environmental Engineering (IMAG), P.O.
Box 43,

6700 AA Wageningen, The Netherlands.

d.a.g.kurstjens@imag.wag-ur.nl

Bo Melander

Danish Institute of Agricultural Sciences, Department of Crop Protection
Research Centre Flakkebjerg, DK-4200 Slagelse, Denmark

Bo.Melander@agrsci.dk

Jan K. Kouwenhoven

Wageningen University, Soil Technology Group, Bomenweg 4, 6703 HD
Wageningen

Jan.Kouwenhoven@user.aenf.wag-ur.nl

Daniel T. Baumann

Swiss Federal Research Station for Fruit-Growing, Viticulture and
Horticulture,

P.O. Box 185, CH-8820 Wädenswil, Switzerland

daniel.baumann@faw.admin.ch



Photograph of some of the participants
of the 4th EWRS Workshop on Physical Weed Control



Table of content

Physical weed management systems

Status Of Physical Weed Control In Arable Production And Vegetables In The Netherlands

Rommie van der Weide and Piet Bleeker 1

Tackling Weed Management In Organic Farming: A Matter Of Applied Ecology

Paolo Bàrberi and Roberto Paolini 3

Sowing Time, False Seedbed, Row Distance And Mechanical Weed Control In Organic Winter Wheat

Ilse A. Rasmussen 5

Soil Treatment For Preventive Weed Control Without Increasing The Erosion Hazards

Reidar Holmøy and Einar Teslo 8

Management Of Weeds In Lettuce: False Seedbed, Soil Preparation And Mechanical Weed Control Options

Piet Bleeker and Rommie van der Weide 15

Mechanical Weed Control In Lupin

Rikke Klith Jensen 17

Spring-Tine Harrowing In Sunflower And Soyabean: Results Of Two-Year Trials

Michele Raffaelli, Andrea Peruzzi and Paolo Bàrberi 18

Mouldboard Ploughing For Weed Control

J.K.Kouwenhoven 19

The Impact Of Harrowing On The Soil-Nitrogen Dynamic Under Spring Wheat - One Year Results From A Loess Soil

Horst H. Steinmann 23

Mechanical Weed Control In Transplanted Sugar Beet

Bo Melander 25

Screening experiments and potential use of cover crops in vegetable production

Lars Olav Brandsæter 26

Relationship Between The Timing Of Seedbed Preparation And The Efficacy Of Pre-Emergence Flaming

Petri Vanhala 27

Important factors influencing the outcome of physical weed control

Effect Of Weed & Crop Variability On Selectivity Of Mechanical Weeders Dirk Kurstjens	28
Optimising Torsion Weeders And Finger Weeders Dirk Kurstjens and Piet Bleeker	30
Can Slurry Injection Improve The Selectivity Of Weed Harrowing In Cereals? Karsten Rasmussen	33
Perspectives Of Mechanical Weed Control In Ryegrass Seed Crops Gerard Borm, Rommie van der Weide and Henk Floot	35
Soil Treatment For Preventive Weed Control Without Increasing The Erosion Hazards Reidar Holmøy and Einar Teslo	36

Weed control techniques

Susceptibility of Sweet Maize (<i>Zea mays</i>) to the Rotary Hoe Preliminary results Daniel Cloutier and Maryse L. Leblanc	37
Susceptibility of Dry Edible Beans (<i>Phaseolus vulgaris</i>, Cranberry Beans) to the Rotary Hoe Maryse L. Leblanc and Daniel Cloutier	38
Susceptibility of Row-Planted Soybean (<i>Glycine max</i>) to the Rotary Hoe Maryse L. Leblanc and Daniel Cloutier	39
Cutting Weeds With CO2 Laser - Preliminary Results Torben Heisel & Svend Christensen	40
Mechanical Weed Control Using Inter-Row Cultivation and Torsion Weeders In Vining Pea Johan Ascard, Nina Olstedt, & Håkan Bengtsson	41
Selective Flaming - Fundamental Measurements And Practical Use Reidar Holmøy , Kai J. Storeheier and Leif-Trygve A. Berge	42
Development Of A New Flaming Machine: Experimental Results On Sunflower Michele Raffaelli, Andrea Peruzzi and Paolo Bàrberi	48

Technical aspects and new machinery

Electroporation - Can We Control Weed Seeds By The Use Of Electric Pulses Applied In Soil ?	
F. Fogelberg.....	50
A New Methodology For Weed Control And Cereal Crop Production Based On Wide Span Vehicles And Precision Guidance: Biotrac	
W.C.T. Chamen.....	51
Intra-Row Weed Control	
J. Bontsema, C.J. van Asselt, G.D. Vermeulen.....	55
Australian Developments in Thermal Weed Control	
R.M. Collins	56
Precision Physical Weed Control	
R.G. Northway and J.N. Tullberg.....	59

Roundtable discussion

Applied Ecological Principles: Intercropping As A Weed Management Component	
Daniel T. Baumann, Lammert Bastiaans and Martin J. Kropff.....	61
Assessment methods for weed control and crop damage & Risks perception and adoption of mechanical weed control in practice	
Rommie van der Weide and Dirk Kurstjens	63

Status Of Physical Weed Control In Arable Production And Vegetables In The Netherlands

Rommie van der Weide and Piet Bleeker

Practical research for arable farming and field production of vegetables (PAV)

P.O. Box 430, 8200 AK Lelystad, the Netherlands

R.Y.van.der.Weide@PAV.AGRO.NL

Backgrounds

The area and the market of organically grown arable products is increasing. In 1999 in the Netherlands around 1% of the total arable area is organically cultivated. The government aims at 10% in 2000. Already 70% of the supermarkets sell organic products; 5% of the arable products sold are organic. The Netherlands is however little in organic production compared to other countries (table 1).

Table 1. **Area biological production in several countries in 1998** (SÖL and biologica, 2000)

Austria	288.000 ha	8.4 %
Denmark	160.000 ha	6.0 %
Finland	137.000 ha	6.3 %
France	235.000 ha	0.8 %
Germany	416.000 ha	2.4 %
Italy	788.000 ha	5.3 %
Netherlands	23.000 ha	1.2 %
Spain	269.000 ha	1.1 %
Sweden	127.000 ha	3.7%
Switzerland	79.000 ha	7.3%
United states	1.800.000 ha	?

Beside the organic production one of the big supermarket chains aims at herbicide free products in 2005. Furthermore, the environmental effects of pesticides are regulated by governmental policy. The number of herbicides allowed is decreasing very fast. The expectation is that only 50% of the active ingredients will be supported for EU registration after 2003. EU cross compliance implementation in the Netherlands force growers to reduce pesticides to get financial support. Rules which are implemented in 2000 are:

- kill the leaf of starch potato at less of 25% of the area with herbicides;
- Treat maize area at least once mechanical and use less than 1-kg active ingredient per hectare.

State of art physical weed control

At this moment in the Netherlands, harrowing is hardly used in conventional production, except in silage maize. In maize, the use of harrowing will increase from less than 15% in 1999 to more than 60% in 2000, because of the cross compliance rules. At this moment it is hardly possible to sell a harrow and has the harrow delivered in time for the season 2000. Hoeing is accepted and regularly used in conventionally grown vegetables, sugar beets and onions at 25 to 75% of the total area. Delayed or split ridging potato is used at more than 50% of the conventionally grown potatoes. In organically cultivated crops, preventive methods; flaming (onion, carrot, chicory, and potato); harrowing a/o. (many crops) and hoeing (many crops) are often used.

Bottlenecks herbicide free production

Nevertheless, a lot of additional hand weeding is needed (table 2). After mechanical control with harrows, hoes and others, for the Netherlands still 223.000 hours hand weeding is needed or 560 man during 10 weeks (area organic production as in 1998). With the plans for 2010 (10% organic production and hand weeding in conventional vegetable production by less herbicide registration of 10 h/ha,) this will increase to almost 3 million hour (7200 man during 10 weeks).

Table 2. Additional hand weeding needed in hour/ha after the mechanical control with harrows, hoes and others in organically grown crops according to research at farms in the Flevo area (Vereijken at Plant Research International Wageningen) at experimental farms at different places in the Netherlands (PAV) and farms at different places besides the Flevopolder with intensified extension by PAV and DLV (BIOM).

Crops	ha	%	Flevo	Land	Biom
Cereals	3000	1,6	7	5	12
Potato	700	0,6	2	7	9
Sugarbeet	340	0,3	85	73	82
leguminous crops	320	2,3	25	15	42
Onion	250	1,4	110	175	177
Carrot	250	3,2	115	155	152
Cabbage	190	1,8	27	30	45
leafy vegetables	64	2,7		55	47

Beside of the costs of this labour, there is a problem with the availability and the management of this labour. Furthermore, mechanical weed control is weather dependent and not very flexible. The results and the amount of hand weeding can significantly differ between years. At last, there are problems with perennial weeds, at some areas and crops with erosion and additional risks on frost damage and to get adequate control of *Solanum nigrum* in late peas.

Solutions

There is a clear need for new or improved technology. Also both preventive methods and mechanical control should be further optimised and used more. Examples and illustrations were given on the effects on further weed control and result of:

- the effect of planting and sowing date in maize and potatoes;
- the effect of planting in stead of sowing in onions;
- covering the soil by spraying with Asofil;
- improved (use of) machinery (f.e. finger weeders, torsion weeders)

It is a big challenge and there is a big market to improve physical weed control. The need for expanding the available knowledge is clear and we should optimally cooperate to accelerate the gathering of knowledge and new technology.

Tackling Weed Management In Organic Farming: A Matter Of Applied Ecology

Paolo Bàrberi and Roberto Paolini

Dipartimento di Produzione Vegetale, Università della Tuscia,

Via S. Camillo de Lellis, 01100 Viterbo, Italy

(pbarberi@unitus.it, rpaolini@unitus.it)

Introduction

Weeds are often recognised as the most serious threat to organic crop production (Penfold *et al.*, 1996; Stonehouse *et al.*, 1996; Clark *et al.*, 1998). Despite this, relatively little attention has so far been paid to weed management in organic cropping and farming systems. Besides this, weed management is often approached from a reductionist perspective. We contend that weed management in organic farming should instead be tackled from a systemic (holistic) perspective due to some peculiar features of such systems.

Time scale

In organic cropping systems, the effects of cultural practices on crop/weed interactions usually manifest themselves more slowly as compared to conventional cropping systems. This happens both in the short- (during a crop cycle) and in the long-term (during one or more crop rotation cycles). It follows that in organic agriculture crop and weed management (1) should be tackled in an extended time domain and (2) needs more integration than in conventional agriculture. Examples on crop fertilisation and direct weed control should help clarify this concept.

Crop fertilisation

Use of organic fertilisers/amendments generally results in slower release of nutrients as compared to mineral fertilisation. Organic fertiliser/amendments may also represent a source of weed seeds, e.g. when farmyard manure or compost are not sufficiently treated (Mt Pleasant & Schlater, 1994). These factors alter crop/weed competition and weed population dynamics both within and across growing cycles, the latter as related to (1) carry over of nutrients and (2) weed seed input from organic materials and/or uncontrolled late-emerging weeds (Bastiaans & Drenth, 1999; Liebman & Davis, 2000). Seasonally variable composition of organic fertilisers/amendments makes it difficult to tailor a weed management strategy for organic farming making use of nutrient manipulation to improve crop competitive ability. In this respect, a partial exception might be the localisation of organic fertilisers/amendments close to the crop row, when this is feasible. In organic farming, nutrient management is also intertwined with tillage system, since some organic amendments (e.g. manure) usually need to be ploughed down while other (e.g. cover crops) can also be profitably managed in reduced- or no-tillage systems.

Direct weed control

Compared to herbicides, physical weed control (PWC) is usually less effective, both in the short- (as related to limited action persistence) and long-term (as related to build-up of the weed seedbank). Lower systematicity of outcome makes the effectiveness of PWC more reliant on that of crop choice and other concurrent cultural practices (e.g. tillage, fertilisation). It follows that enhancement of PWC can only occur when the problem is approached holistically. In particular, successful PWC must rely on concurrent application of cultural weed management, aimed to (1) reduce weed emergence by using preventive methods (crop sequence choice, smother crops, primary tillage, false seedbed technique), and (2) reduce weed competition by improving crop competitive ability (appropriate use of crop genotypes, transplants, sowing/planting pattern, fertilisation strategy). This approach is of the utmost importance in organic farming, where herbicides cannot be used even in emergencies.

Key points

From what said above, it is clear that fine-tuning of weed management in organic farming should rely upon increased knowledge on (1) crop and weed eco-physiology and (2) weed population dynamics as influenced by cropping system structure (crops and associated cultural practices). These information would allow a better understanding of those factors driving crop/weed competition in organic farming systems. Clearly, crop and weed management would have to be tackled as an integrated issue making full use of agro-ecological knowledge (Altieri, 1995). In this respect, cover crops might represent an ideal link between soil, nutrient, and weed management in organic agriculture (Bàrberi *et al.*, 1998).

Perspectives

Despite its importance, examples of a holistic approach to weed management in organic farming are very scarce in the world literature. This is probably attributable to the conflict between the need of implementing long-term research (which is particularly important in an organic context) and the constraints posed by short-term research funding. Besides this, researchers themselves need to overcome their reluctance to long-term studies, partly arising from methodological difficulties. Modelling might help bridging this gap but models outcome would always have to be validated by results of concurrent long-term field experiments. Research priorities would have to be set globally but adjusted to local situations. In this respect, a system-based approach would likely set the scene for the implementation of participatory research in organic farming.

References

- ALTIERI MA (1995) Weed ecology and management. In: *Agroecology. The Science of Sustainable Agriculture* (MA Altieri ed), pp. 283-305, Westview Press, Boulder, CO.
- BÀRBERI P, CAPORALI F, CAMPIGLIA E & MANCINELLI R (1998) Weed community composition in a mixed farming system in Central Italy. *Proceedings Workshop "Mixed Farming Systems in Europe"*, Dronten, 25-28 May, ed. H. Van Keulen, E.A. Lantinga, H.H. Van Laar, A.P. Minderhoudhoeve-reeks nr. 2, Landbouwniversiteit Wageningen, 71-77.
- BASTIAANS L & DRENTH H (1999) Late-emerging weeds; phenotypic plasticity and contribution to weed population growth. *Proceedings 11th EWRS Symposium*, Basel, 28 June-1 July, 3.
- CLARK MS, FERRIS H, KLONSKY K, LANINI WT, VAN BRUGGEN AHC & ZALOM FG (1998) Agronomic, economic, and environmental comparison of pest management in conventional and alternative tomato and corn systems in northern California. *Agriculture Ecosystems & Environment* **68**, 51-71.
- LIEBMAN M. & DAVIS AS (2000) Integration of soil, crop, and weed management in low-external-input farming systems. *Weed Research* **40**, 27-47.
- MT PLEASANT J & SCHLATER KJ (1994) Incidence of weed seed in cow (*Bos* sp.) manure and its importance as a weed source for cropland. *Weed Technology* **8**, 304-310.
- PENFOLD CM, MIYAN MS, REEVES TG & GRIERSON IT (1995) Biological farming for sustainable agricultural production. *Australian Journal of Experimental Agriculture* **35**, 849-856.
- STONEHOUSE DP, WEISE SF, SHEARDOWN T, GILL RS & SWANTON CJ (1996) A case study approach to comparing weed management strategies under alternative farming systems in Ontario. *Canadian Journal of Agricultural Economics-Revue Canadienne d'Economie Rurale* **44**, 81-99.

Sowing Time, False Seedbed, Row Distance And Mechanical Weed Control In Organic Winter Wheat

Ilse A. Rasmussen

Dept. of Crop Protection, Danish Institute of Agricultural Sciences,
Research Centre Flakkebjerg, DK-4200 Slagelse

(IlseA.Rasmussen@agrsci.dk)

Introduction

In organic farming, mechanical weed control in winter wheat is often difficult to carry out in the fall, and may damage the crop, and weed harrowing in the spring is not effective against erect, tap-rooted weeds such as *Tripleurospermum inodorum*, *Papaver rhoeas*, *Brassica napus* and others which have been established in the autumn. Experiments in conventional agriculture indicate, that while the yield decreases with delayed sowing time when using herbicides, this is not so in untreated plots, and the weed biomass decreases with delayed sowing time. The false seedbed technique has not been widely used in winter wheat in Denmark, but some experiences indicate that this might further decrease the weed infestation. Experiments with mechanical weed control in spring cereals show that some of the erect species, that cannot be controlled by harrowing, might be controlled by row hoeing at larger than normal row distance.

Materials and methods

Some experiments concerning sowing strategy and intensity of mechanical weed control, which included row distance, were conducted. The description of the experiments and the treatments can be

Table 1. Experiments carried out at two locations over two years.

seen in brief in table 1. Weed occurrence was counted in the spring before weed control at

Experiment	1	2	3
Year	1998	1999	1999
Location	Flakkebjerg		Foulum
Soil type	Sandy loam		Loamy sand
Weed flora	<i>P. rhoeas</i> , <i>T. inodorum</i> , <i>Veronica spp.</i> , <i>Poa annua</i>		<i>Stellaria media</i> , <i>Viola arvensis</i> , <i>Veronica spp.</i> ,
Weed density	> 500 m ⁻²	> 200 m ⁻²	< 50 m ⁻²
Treatments			
Row distances	12/24 cm	12/24 cm	12.5/25 cm
Sowing strategies	-	Early/Late/False Seedbed	
Control treatments	Untreated/Herbicide	Untreated/Herbicide	Untreated/Herbicide
Mechanical weed control treatments	High/low intensity	Harrowing at 12 cm/ Harrowing and hoeing at 24/25 cm	

Flakkebjerg, and counted and weighed 4-6 weeks after weed control in all experiments. Yield was measured.

Results

In experiment 1, high intensity weed control at larger row distance decreased the amount of weeds compared to the other treatments at larger row distance. The yield was highest at normal row distance.

In experiment 2, there was a tendency before weed control for less weeds m^{-2} at the late sowing time and most at the early. After the weed control, there was most biomass of weeds in the untreated and least in the herbicide treated. There was a tendency for less weed biomass at larger row distance, except with herbicide treatment. For *P. rhoeas*, which was the most important weed in the experiment (fig. 1-3), there seemed to be an interaction between sowing strategy and weed control, so that in untreated, there was most biomass of *P. rhoeas* with false seedbed, while with mechanical weed control, there was most with early sowing. The yield was highest with herbicide treatment, and tended to be highest at the early sowing time. With mechanical weed control, it tended to be highest at larger row distance.

In experiment 3, there was more weed biomass after weed control at the early sowing time than at the others. For *S. media* there was more biomass at larger row distance without weed control, but less with. There were no differences in the yield, although a tendency for higher yield at early sowing might be detected.

Discussion

The results underline the importance of choosing weed control strategy, including preventive measures, according to the weed flora in the field. In the experiment with low weed pressure and without erect weeds, there was very little effect of sowing strategy and row distance. In such a case, the winter wheat might as well be sown early, in order to avoid possible yield loss by later sowing, and at normal row distance to enhance the competitiveness of the crop. In the experiments with high weed pressure and erect weeds, the weed control was better with late sowing and large row distance (high intensity control), even though this was not always reflected in the yield. However, the trade-off for lower input to the soil seed bank in organic systems should be enough to balance off the risk of smaller yield.



Fig. 1. Winter wheat sown early, normal row distance, mechanical weed control.



Fig. 2. Winter wheat sown late, normal row distance, no weed control.



Fig. 3. Winter wheat sown early, large row distance, mechanical weed control.

Soil Treatment For Preventive Weed Control Without Increasing The Erosion Hazards

Reidar Holmøy and Einar Teslo

Department of Agricultural Engineering, Agricultural University of Norway

Abstract

Soil tillage, particularly ploughing, is well known as perhaps the most important method for preventive weed control. According to later investigations however, this is also known as one of the most serious reasons for erosion. This opposition of course is a great problem in environmental friendly agriculture and was an important background for the project: «Soil treatment systems for preventive weed control in ecological agriculture» at our Department. The project consisted of four large and fairly equal field experiments with different growing conditions on silty sand to loam type erosion exposed soils. Experimental treatments were main soil preparation with 9 to 11 methods and post harvest stubble treatments with two methods. Cereals were grown on all fields except one with grain fodder in one of the years.

The main results from the project concerning weed control and yield of grain were as follows:

- Main soil preparation by means of ploughing (depth 12-14 cm or 20 cm) in general gave
- better weed control and better grain yield than did preparation by means of harrowing with a tine cultivator with «duckfoot» shares, a rotary spike cultivator or a rotary harrow (depth 10 cm)
- However post harvest stubble treatment in the autumn by stubble cutting (cutting the cereal stubbles and the weed) or by means of stubble harrowing with a tine cultivator with «duckfoot» shares (depth 7 cm), mostly increased the weed efficiency and the yield for the main soil preparation by harrowing. This increase more or less compensated for the difference between ploughing and harrowing.
- Totally, stubble harrowing was better than stubble cutting. Later investigations however, indicate that stubble cutting just after harvesting and 4 weeks later may give better weed results than only one stubble cutting 4 weeks after harvesting, such as we did in the project.
- No unambiguous difference in weeding efficiency and grain yield were found between ploughing in autumn and ploughing in spring, between deep (20 cm) and shallow (12-14 cm) ploughing, between using a soil packer after the plough or not, or between using sub shares under the ploughs or not. Not either were in general found significant difference between the above reported harrowing tools for the main soil preparation in the spring.

The conclusion is that at erosion exposed soils, where spring tillage therefore is advised under Norwegian conditions, ploughing deep or shallow in the spring and spring harrowing combined with stubble treatment in the autumn, to a certain extent, will give satisfactory weed control and yield. From before we know that spring ploughing on heavy clayey soils mostly gives a low yield under Norwegian conditions, but also that we may well continue to plough such soils in autumn without running any unacceptable erosion risk.

Introduction

The general background in 1988 for our Department, in co-operation with the Norwegian Plant Protection Centre, to deal with the technical parts of the field non-chemical weed control was the environmentally inspired, general realisation of the necessity of starting such investigations on this field after decades of standstill. The direct non-chemical weed control in the growing season was investigated in the project «Combined ecological-chemical weed control», in the years 1989 to 1993. However it had all the time been obvious that it also would be essential to deal much more seriously with the preventive weed control here than in ordinary chemical weed control. Especially it is a problem that the new forms for soil preparation and sowing, developed to reduce the erosion, also reduce the preventive weed control efficiency from the soil preparation. Investigations to study this were accomplished in the project «Soil treatment for preventive weed control in ecological

agriculture» at The Department of Agriculture Engineering during the years 1993 to 1995. Reidar Holmøy was the project leader and Einar Teslo, as a candidate for the doctor degree, was the effecting man in the new project.

It was an important premise for the project that it should complete other projects in mechanization of ecological agriculture, soil preparation in general and preventive weed control. As far as the given resources allowed, it was also prepared for investigations in the effect on the biological activity on the soil from the different soil treatments. As this part of the calculations and the final doctor thesis are still not ready, the subject matter here is based on preliminary reports from TESLO (1994), TESLO (1995) and HOLMØY (1996) and some of the other results from the project which are still not published.

General arrangement and accomplishment

The investigations were planned with four large and fairly equal field experiments with different growing conditions on silty sand to loam type, erosion exposed soils. Experimental factor 1 was post harvest stubble treatments about 4 weeks after harvesting to prevent dissemination from the weed seeds and growth of the weed organs for propagation and storage of nutriment. Experimental factor 2 was the main soil preparation by 9-11 soil preparing methods or tools in autumn or spring, which, among others, have the purpose to bury and kill both annual weeds and perennial weeds before sowing in the spring. The results were registered by counting the surviving weeds in their young stage and, just before harvesting, by assessing the total amount of weeds, couch grass and surviving ley grasses from the previous years. Methods and reliability of assessing biological data are described by HOLMØY (1966). The yield was registered by weighing. The investigation fields were as follows:

One field at the farm Teslo in the village Brandbu, Norway, at silty sand. Investigations started in spring 1993. Open field (that means not used for ley) in the years before start.

One field at the Voll experimental field for ecological agriculture at the Agricultural University of Norway at loam. Start in autumn 1993. Ley in the years before start.

Two fields (I and II) at the Bjørnebekk farm on the Agricultural University at silty sand to loam with rather much humus. Start in 1993, spring and autumn respectively. Ley before start.

The Voll field was reorganised to ecological (organic) management two years before the investigations started while the other fields were reorganised at start. As the fields Teslo and Bjørnebekk I had no stubble treatments in the autumn 1992, the 1993 experiments there were not complete, and the results from these experiments are not reported here.

Experimental plan with illustrations

The experiments formed one link in the crop rotation plan after arable crops or ley

Treatments

Factor 1 - Post-harvest treatments in autumn

- a - No soil treatment
- b - Straw and stubble cutting
- c - Stubble cultivation with a tine cultivator, with «duckfoot» shares, 7 cm

Factor 2 - Main soil preparing (soil tillage)

- A - Plough, 20 cm, autumn
- B - Plough, 20 cm, spring
- C - Plough, 20 cm, spring, soil packer
- D - Plough, 12-14 cm, spring, soil packer
- E - Plough, 12-14 cm, autumn, sub-shares
- F - Plough, 12-14 cm, spring, subshares
- G - Plough, 12-14 cm, spring, soil packer, sub-shares
- L - Rotary blade cult. 5 cm, the same 12 cm, roller, plough 20 cm, soilpacker (operations in order) spring
- H - Tine cult. «duckfoot» shares 10 cm depth, spring
- J - Rotary spike cultivator, 10 cm, spring
- K - Rotary harrow, 10 cm, spring

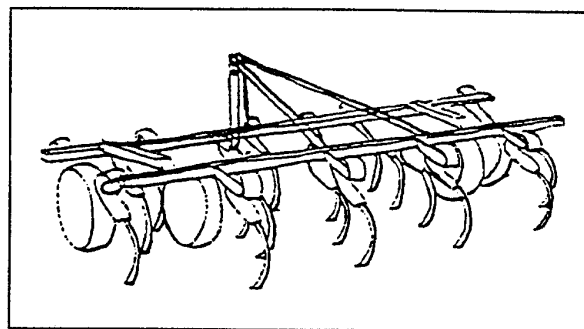

Figure 3. Tine cultivator

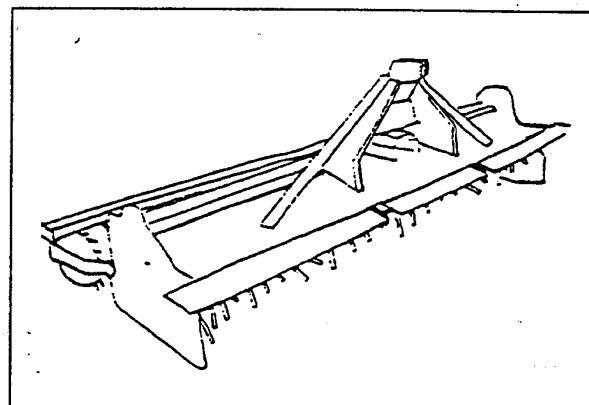

Figure 4. Rotary spike cultivator

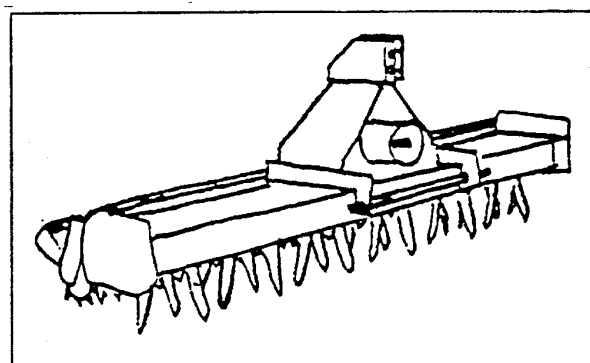

Figure 5. Rotary harrow

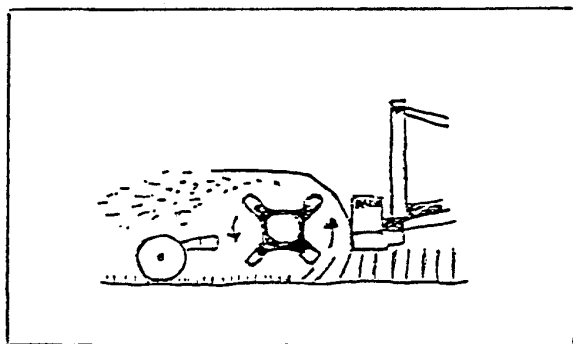

Figure 1. Stubble cutter

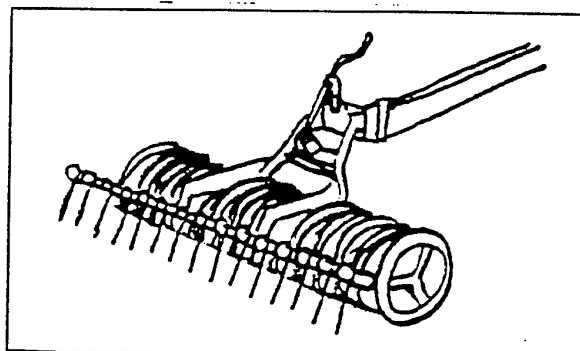

Figure 2. Soil packer

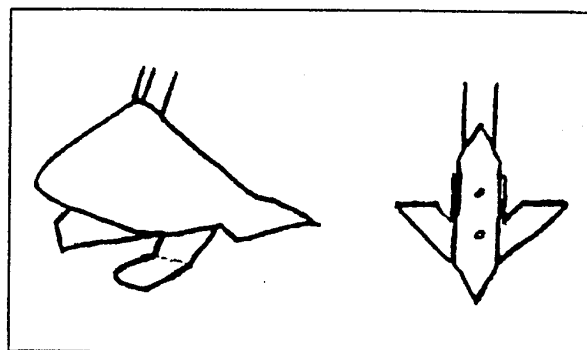

Figure 6 Sub-share and cleaning-share

Results

Examples of the result

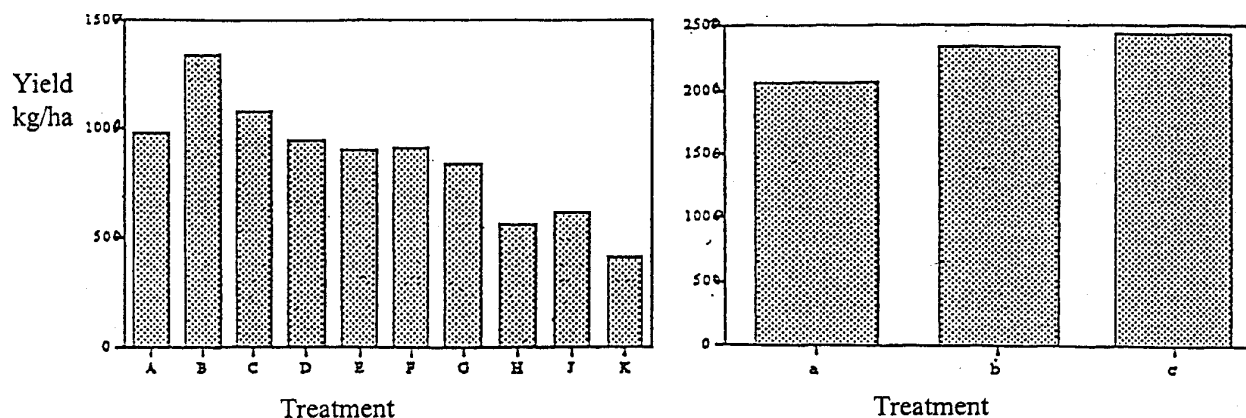

Figure 7. Left: Example from the field Bjørnebekk I 1994, yield: On an average ploughing was better than harrowing (i.e. the mean result of the treatments A,B,C,D,E,F,G was better than the mean result of H,J,K). Further, treatment B was better than treatment K..
 Right: Example from the field Teslo 1994, yield: Tendency of increasing crop for increasing stubble treatment.

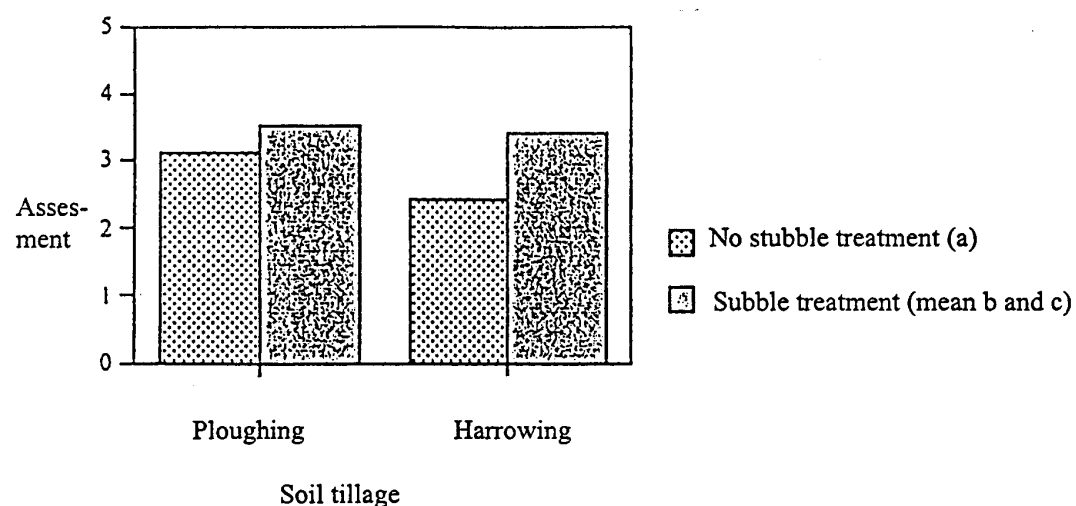

Figure 8. Example from the field Teslo 1995, Assessment marks of the total amount of weed before harvesting (Mark 1 is much weed, mark 5 is nearly no weed): Interaction where the stubble treatment had a larger positive effect on the harrow results than on the ploughing result. The difference between ploughing and harrowing has decreased or nearly disappeared, as, happened here.

Survey of the results

Table 1. Survey of all the results. (Annual weeds register by counting the numbers, other weed results by assessing the amount (mark 1-5) ¹⁾ and the yield by weighing (kg/ha)

Eksperimental tasks	Variable	Field							
		Teslo 1994	Teslo 1995	Voll 1994	Voll 1995	Bjb. I 1994	Bjb. I 1995	Bjb. II 1994	Bjb. II 1995
		Plough versus harrow ^{2 and 3)}	Young weeds	P	ten. P	P	ten.P	P	ten.P
	Couch g. early	0	0	0	0	ten.H	ten.P	0	ten.P
	Couch g. late	ten.P	0	0	0	H	0	ten.H	ten.P
	Ley g. late	-	-	P	P	ten.P	P	P	P
	Tot. weed late	ten.P	ten.P	ten.P	ten.P	P	ten.P	P	0
	Yield, kg/ha	P ⁶⁾	ten.P	0	0	P ⁷⁾	P	P	0
Differences between stubble treatments ⁴⁾ .	Young weed	ten.b	ten.a,c	0	0	ten.b	ten.bc	ten.a,b	ten.bc
	Couch g. early	0	0	0	0	ten.bc	ten.bc	0	ten.c
	Couch g. late	ten.c	0	ten.c	0	ten.c	bc	ten.bc	c
	Ley g. late	-	-	c	0	ten.c	ten.c	bc	ten.c
	Tot. weed late	ten.c	bc	ten.c	0	b	ten.c	ten.bc	ten.abc
	Yield kg/ha	t,b,c ⁷⁾	ten.bc	ten.a,b	ten.b	ten.b	ten.c	bc	ten.a,b
Interac. betw. plough/harrow and stubble tr ⁵⁾ .	Young weeds	0	0	Hb	Hbc	0	Hbc	0	Hbc
	Couch g. early	0	0	Hbc	Hbc	Pbc	Hbc	0	Hbc
	Couch g. late	Hc	Pbc	0	Hbc	Pbc	0	0	0
	Ley g. late	-	-	Hc	Hc	Hc	Hbc	Hbc	0
	Tot. weed late	Hc	Hbc ⁸⁾	Hc	Hbc	Pbc	Pc	0	0
	Yield kg/ha	Ha,b	0	0	Pbc	Hb	Hbc	Hb	Hc

1) Mark 1-5, see fig 8, figure text)

2) Ten. or t. means tendency to-- .

3) P means that ploughing was best, H that harrowing was best and 0 that it was no sign. differences.

4) b means that treatment b was better, or tended to be better, than both a and b separately. b,c means that both b and c were better than a. bc means that the average of b and c was better than a, and so on for all stubble treatments.

5) Hc means that the interaction is positive for H and c , and so on for the other interactions, 6, 7 and

8) The results here are illustrated in figure 7 left, figure 7 right and figure 8 respectively.

Discussion

Besides what is seen from table 1, the investigations gave some rather sporadic results. The most important ones show that the results of the different ploughing alternatives differed. Some places deep ploughing tended to be the best. Regarding ploughing time, some time the spring was best and other times the autumn was best. Soil packer and sub shares were sometimes favourable other times not.

Main soil preparing with rotary spike cultivator was rather often better than using tine cultivator and multirotor cultivator. This was especially valid for the experiments of the field Voll both years.

However, table 1 shows that the by far most differences between the results of the main soil preparation treatments were more or less moderated because of the interaction between the main soil preparation and the stubble treatments. The latter, especially with the stubble cultivator, nearly always was favourable where the following main soil preparation treatment had the poorest effect. The effect of the stubble cutting was variable, and in all poorer than the effect of stubble harrowing. However later investigations at our department by ENDRERUD and BØRRESEN 1996), indicate in our opinion that cutting two times, the first just after harvesting and the second about 4 weeks later, may give better results than we got here by using only one cutting about 4 weeks after harvesting. As stubble cutting does not loosen the soil and thereby are more secure than harrowing with regard to erosion, it would be important to examine this interaction further.

It was not much couch grass in our fields, but the survived ley grass had effect as kind of perennial weed, especially in the fields Voll 1994 and Bjørnebekk I and II 1994. These fields had been used for ley the last years before the experiments started. At the field Bjørnebekk II, where the ley was oldest, this interaction (main soil preparation x stubble treatments) was further from nullifying the difference between ploughing and harrowing, than on the other fields, concerning ley grass control, total weed control and yield.

SKUTERUD et al (1995) found that autumn ploughing gave the best weed control, spring ploughing the next best, and harrowing the poorest weed control. Further on, stubble harrowing tended to reduce the weed where spring ploughing and spring harrowing were used in the spring as the main soil preparation. When we attained better results for spring harrowing combined with autumn stubble treatment and for spring ploughing in our investigations it may be connected with our decision of not using fields with too clayey soil.

Conclusion

According to both our results and earlier results, it seems as if we, in a higher degree than supposed, may manage both the erosion problems and the preventive weed control provided that there is not very much perennial weed on the field. Provided the same conditions as in the investigations done, much may be attained by a flexible combination of spring ploughing and spring harrowing combined with autumn stubble treatments. Our experimental fields did not include the very clayey soil. The reason is that many earlier experiments have showed both that the yield are normally reduced if clay soil are spring ploughed, and that such soil may usually be autumn ploughed without any important erosion hazards. As an illustration we may refer to a report from the institution «Centre for Soil and Environmental Research» near the Agricultural University, which conclude by saying that about 42% of the agricultural land in Ås and the neighbouring community are clayey and may therefore be autumn ploughed (ROGNERUD 1993).

It would now be important to carry on with a similar, but more long-lasting, investigation project so the long-range effect and possible improvements of the mentioned soil preparing systems may be further investigated.

References

- ENDRERUD, H. CHR. and BØRRESEN, T., 1996. Sluttrapport for prosjektet: Undersøkelser av halmnedbryting og ugrasvirkning ved halmstubbkutting høst og vår. (Final report for the project: Investigations of the decomposition and weed effect of straw stubble cutting in autumn and spring. The Department of Ag. Eng. Agr. Univ. of Norway.
- HOLMØY, R. 1996₁). Sluttrapport for forskningsprosjekt. Jordbehandlingssystemer for forebyggende ugrasbekjempelse i økologisk landbruk. (Final report for the research project Soil treatment

systems for preventing weed control in ecological agriculture.) Dep. of Ag. Eng. Agr. Univ. of Norway.

HOLMØY, R. 1996₂, Skjønsmessige karakterer for registrering av biologiske data. (Summary: Assessed marks for registration of biological data.) ITF Report no 78/1996. (Report in English in a ready made manuscript.)

ROGNERUD, B., 1993. Årungenprosjektet. Delrapport II. (The Årungen project. Part 2.) Sentre for Soil and Environmental Research, Norway. Employer: The county of Aas

SKUTERUD, R., SEMB, K., SAUR, J., and MYGLAND, S. 1995. Endret jordarbeiding og utvikling av ugrasfloraen. (Altered soil tillage and the progress of the weed flora). Soil and crop production 1996. Grain crops, potato and environment. Results from investigations 1995.

TESLO, E., 1995. Soil treatment for preventive weed control in ecological agriculture in South-eastern Norway 1994, Proceedings 10th IFOAM Conference, Lincoln University, New Zealand, 11.-16. December 1995.

TESLO, E., 1995. Jordarbeiding og forebyggende ugrasbekjempelse. (Soil tillage and preventive weed control.) Fagnytt Teknikk no. 5 1995, The Infocenter, The Science Park at Aas, Norway .

Management Of Weeds In Lettuce: False Seedbed, Soil Preparation And Mechanical Weed Control Options

Piet Bleeker and Rommie van der Weide

Applied Research for Arable Farming and Field Production of Vegetables (PAV)

P.O.Box 430, 8200 AK Lelystad, the Netherlands. Tel. (+31) 320-391111

P.Bleeker@pav.agro.nl and R.Y.van.der.weide@pav.agro.nl

False seedbed and soilpreparation

In one experiment in 1999 was researched what is the best method to make a new seed bed after making a false seedbed. The question was, is it possible to optimise the effect of making a false seedbed to reduce the number of weed plants in a crop. Four weeks before planting the iceberg lettuce there was made a false seedbed and in one object two weeks before planting.

Before planting the lettuce the subjects of soil preparations, are: a. The rotary harrow (it worked about 4 cm. in the soil.), b. The rotary harrow who was covered with black plastic, c: The rotary harrow who was covered with black plastic with infra red light under the plastic, d. The hoe who worked 1 á 2 cm in the soil, and e. One object with glyfosate. The standard was making a seedbed before planting with a rotary harrow.

Table 1 shows that the soil preparation with the covered rotary harrow and with the hoe are the best. When the seeds of the weed did not see any light there emerged 30 % less weed plants. The effect of the hoe is the same because the working dept is a few centimetres. The effect of the glyfosate was very not good. There was not made a new seedbed before planting. The emerged weeds just under the soil were not killed and grew very fast.

Table 1. Effect soil preparation before planting after making a false seedbed. % emerged weed plants and % biomass.

Treatment ↓	% emerged plants	% reduce biomass
Rotary harrow	56 %	74 %
Rotary harrow (covered)	26 %	82 %
Rotary harrow (covered + infra red light)	31 %	75 %
Hoe	26 %	78 %
Hoe (2 weeks falsseedb.)	24 %	26 %
Glyfosate	31 %	- 50 %

Mechanical options

In 4 field experiments in 1998 and 1999 at two soil types the effect off the fingerweeder, the torsionweeder and the harrow was observed. Two weeks after planting the iceberg lettuce were firmly anchored in the soil. The first year we tried the harrow in the lettuce on clay. It did not work 6 till 15 % of the plants were uprooted trough the tines of the harrow. So we only use on clay in this object the hoe.

The uprooting on the sandy soil was about 6 %. The % head off lettuce was decrease from 90 to 75 %. The Fingerweeder and the torsionweeder are softer for the crop and also the effect off weedcontrol was better. On clay in '98 we were too late with the weedcontrol the weedplants are to large The effect of weed control was to low.

Table 2 Effect of weedcontrol and the yield of the experiments

	% weed control				Yield (untreated is 100)		
	clay		sand		clay		sand
	'98	'99	'98	'98	'98	'99	'99
Hoe + harrow	67 *	79 *	90	94	101 *	97 *	91
Hoe + fingerw	78	99	90	94	98	98	102
Hoe + torsionw	75	95	92	94	99	97	100
5 l. carbeetamide and 1,5 chloorprofam	67	59	98	94	97	101	99

Mechanical Weed Control In Lupin

Rikke Klith Jensen

*Danish Institute of Agricultural Sciences, Department of Plant Protection,
Research Centre Flakkebjerg, DK-4200 Slagelse, Denmark.*

RikkeK.Jensen@agrsci.dk

Abstract

New genotypes of determining spring-sown lupin with early flowering and early ripening provide new possibilities for growing lupin in Denmark. Herbicides are not optional for organically grown lupin, and in Denmark there are no herbicides available for use in conventionally grown lupin. Experiences in mechanical weed control in combinable pulses are quite limited, however, in broad beans and peas some perspective results have been achieved with mechanical weeding. Swiss trials with hoeing and harrowing in broad beans have shown that high weed control effects can be obtained (Irla, 1995) and comparable good results have been obtained in peas with early weed harrowing before and just after the emergence of the peas (Rasmussen, 1993).

This presentation focuses on the response of lupin to increasing weed harrowing intensity as well as to elucidate the possibilities of carrying out mechanical weed control strategies. 5 factorial trials were carried out in 1997, 1998 and 1999 using mechanical weed control in lupin. 3 tolerance trials, one in 1997, one in 1998 and one in 1999 (experiment 1, 2 and 3) and 2 strategic trial were carried out in 1998 and 1999 (experiment 4 and 5). In order to assess any possible damages to the crop caused by mechanical weed control, the weeds were removed by hand in subplots of 1 m². The lupin plants from the subplots were harvested by hand at the time of maturity.

To summarise, the results of increasing weed harrowing intensity (experiment 1, 2 and 3) reduced the number of lupin plants in a linear way in every year and the reduction was unaffected by row distance and lupin species. Lupin yield was unaffected by increasing crop soil cover which indicates that both the yellow and the narrow leafed lupin seem to have a very high tolerance against even intense weed harrowing. However, the results from experiment 3 gave a slight yield reduction at very high intensities mainly because of a severe reduction in lupin plant numbers. This reduction happened due to an unworkable soil which made it difficult to obtain the desired crop soil covers. Comparisons between the strategies in experiments 4 and 5 showed that there was no significant difference in the weeding effect whether sole weed harrowing or sole hoeing were used. Only by combining weed harrowing with hoeing a significantly better weeding effect was found in experiment 4.

The narrow leafed lupin did not compete well against high weed pressure due to the low ramification of the lupin, and controlling the weeds resulted in an yield increase. In contrast, the competitiveness of the yellow lupin against weeds was good, as a result of the heavy ramification of the lupin, but the yield from the yellow lupin was very low and the late ripening time was very problematic. Due to the high yield from the narrow leafed lupin and the early ripening, the narrow leafed lupin will be the most interesting species to grow in the future.

Reference

- Irla, E. 1995. Anbautechnik und Unkrautregulierung bei Ackerbohnen. FAT-Berichte nr. 460.
Rasmussen, J. 1993. Experimental approaches to mechanical weed control in field peas. IXème Colloque International sur la Biologie des Mauvaises Herbes.

Spring-Tine Harrowing In Sunflower And Soyabean: Results Of Two-Year Trials

Error! Bookmark not defined. Michele Raffaelli*, Andrea Peruzzi* and Paolo Bàrberi**

*D.A.G.A.E. Division Agricultural Machinery and Farm Mechanisation, University of Pisa, via del Borghetto 80, 56124 Pisa, Italy, mraffaelli@agr.unipi.it, aperuzzi@agr.unipi.it.

**Dipartimento di Produzione Vegetale, University of Tuscia, via S. Camillo de Lellis, 01100 Viterbo, Italy, pbarberi@unitus.it.

The present study aimed to investigate the possibility of using spring-tine harrowing for weed control on sunflower and soyabean, two of the main spring-summer crops in Central Italy. Low-input and organic cultivation of sunflower and soyabean is increasing and it is thus needed to find effective implements for direct weed control.

Field trials were carried out in 1998 and 1999. The experimental treatments included one or two passes of a spring-tine harrow combined with four tine adjustments, a "conventional" herbicide treatment and an unweeded control. Mechanical weed control was performed with a 3 m wide spring-tine harrow; tines were adjusted as to form an angle between the upper part of the tine and the perpendicular to the soil surface of -30° , -15° , 0° and $+15^\circ$, in order to achieve a different aggressiveness of the treatment.

In sunflower, it was never possible to perform the second pass with the spring tine harrow because the plants grew too brittle and thus serious crop damage was likely to occur. In 1998, the highest grain yield was obtained with herbicide use and the two most aggressive tine adjustments (0° and $+15^\circ$), although the differences with the other two adjustments were not significant. All treatments gave a grain yield higher than that of the unweeded control. In 1999, grain yield of sunflower did not differ between mechanical and chemical weed control, while yield of the unweeded control was significantly lower. In this year, chemical weed control was not very effective because of the high density of volunteer sunflower, which emerged four years after being grown in the same field. In both years, weed biomass at harvest followed the same trend observed for sunflower grain yield.

In 1998, grain yield of the herbicide-treated soyabean was significantly higher than in any other treatments. Spring-tine harrowing seemed slightly more efficient when performed once, or twice with the less aggressive tine adjustment (-30°). In contrast, in 1999 grain yield in spring-tine harrowed soyabean was comparable to that obtained with herbicides, and even higher with the most aggressive treatment ($+15^\circ$ two passes). In both years, the unweeded control had a significantly lower grain yield and a higher weed biomass.

This first outlook on results indicates that it is possible to achieve effective weed control in sunflower and soyabean by means of spring-tine harrowing while preserving crop yield. Further information on this trial will shortly be available. However, there is a clear need to perform other field experiments in order to better understand the interactions between tine adjustment, on one side, and soil and crop conditions, on the other side, as to optimise weed control and crop selectivity.

Mouldboard Ploughing For Weed Control

J.K.Kouwenhoven

Wageningen University, Soil Technology Group, Bomenweg 4, 6703 HD Wageningen.

<mailto:Jan.Kouwenhoven@user.aenf.wag-ur.nl>

Summary

Mechanical weed control during a crop growing cycle is carried out during each of the 4 phases in tillage around the year: stubble cultivation, main tillage operation, seedbed preparation and inter-row cultivations. Generally, when discussing mechanical weed control, the emphasis is put on the last operations. However, the main tillage operation, mostly mouldboard ploughing, cuts, uprootes and covers weeds present and relocates seeds from the surface to a depth from where they cannot emerge. This is caused by the unique soil inversion action of the mouldboard. Therefore, mouldboard ploughing is the best preventive weed control measure, especially in organic farming but also in regular farming, both in moderate climates and in the (humid) tropics. The weed controlling effect of ploughing is positively related with the ploughing depth. A regular ploughing depth of 25-30 cm can be considered as an insurance premium.

Introduction

Mechanical weed control in agriculture is generally carried out by one or another tillage operation. Tillage promotes the mortality of the seeds by stimulation of germination of weed seeds in the soil e.g. from 12-22% to 25-35% (Aarts & Van den Brand, 1982) and kills the majority of the weeds present at the time of operation. On the other hand, tillage like weed harrowing, brings seeds in a position from where they can germinate and emerge. In UK people were even of the opinion that weed control was the only reason to till the soil. When it became possible to control weeds by herbicides and direct drilling was introduced, it became clear that the idea was not correct.

Mechanical weed control is generally referred to as a number of inter-row operations. However, every tillage operation influences and mostly controls the weed growth (Kuipers, 1975), even when weeds are also controlled by herbicides. Weed control by tillage occurs during 4 phases: it starts with 1-2 stubble cultivations. Then the main tillage operation, generally carried out with a mouldboard plough that buries weeds, weed seeds and crop residues. Weed control by tillage is continued during seedbed preparation and finalized by inter-row weed control. Operations of the first and second phase can be considered as mainly preventive and those of the third and fourth phase as repressive.

Weeds are controlled by the following tillage tool actions: cutting, uprooting and covering with soil of the weeds present. Often more than one of these tool actions occur, e.g. during ploughing.

Soil inversion by ploughing

Mouldboard ploughing has proven to be the best preventive operation for weed control in the (humid) tropics (Van der Sar, 1976) as well in moderate climates (Kouwenhoven, 1984; Rasmussen, 1982). This is caused by the unique soil inverting action of the mouldboard plough. The mouldboard is even supposed to be developed to control root-propagated weeds in humid climates. Mouldboard ploughs can handle small and large weeds by cutting and by covering. In an experiment the percentage of weeds covered by a mouldboard was 95%, by a disc-harrow 48% and by tined cultivation 5%. The weed covering effect of ploughing is considerably improved by the application of a skimmer.

Moreover, ploughing places a (relatively small) amount of weed seeds in a position in favour of easy germination and by buries the rest of the seeds for at least 1 year. The amount of viable buried seeds decreases by about 10% per year. Weeds seeds emerge only from the top few centimeters of the surface. Therefore, without soil inversion by mouldboard ploughing the weed problem will generally be greater (Kuipers, 1981).

Non-soil inverting tillage

In organic farming, the weed controlling effect by disturbance of the soil and soil biota is often minimized by non-inversion tillage (Hoffmann, 1983). The difference between the effect of mouldboard ploughing and tined cultivation with duckfeet in autumn on clay soils on seedbed quality is small. Tined cultivation leaves seeds and uprooted weeds more or less close to the surface from where seeds can germinate and emerge, which is promoted by the relatively fine seedbed. Therefore, after tined cultivation, more annual and perennial weeds will occur in the 2nd and 3rd year after the tined cultivation (Kouwenhoven, 1984, 1986). Because organic farmers do not use herbicides, ploughing is especially for them essential. The appropriate depth of ploughing, however, is still subject of debate.

Ecoploughing

Organic farmers want to promote structure building by soil biota instead by tillage. Therefore they want to reduce ploughing depth to 8-16 cm. In The Netherlands, Rumptstad RSI developed an "ecoplough" characterized by good soil inversion at ploughing depths of 10-18 cm, with 7 or 8 bottoms, a total working width of 2.1 m and a working speed of about 6 km/h. Shallow ploughing with the ecoplough results in a smooth surface, facilitating the preparation of a seedbed consisting of fine, strong, stable and moist aggregates. A well crumbled seedbed is associated with a high water-holding capacity (Kuipers, 1963). Moreover, organic matter, nutrients, soil biota and weed seeds are concentrated high in the profile (Kouwenhoven et al., 1999). After ecoploughing in 1996 in the top 6 cm 11% more seeds were found than after usual ploughing (Van Melick, 1996). These conditions will promote not only crop growth, but also weed growth.

In organic farming practice (mechanical) weed control in onions was found to be impossible after ecoploughing to depths of 12-14 cm. Especially sow thistle (*Sonchus arvensis* L) and colts foot (*Tussilago farfara* L) caused problems. For this reason, organic e.f. NZ27 didnot want to continue ecoploughing experiments (Kouwenhoven, 1998) and returned to their regular depth of 20 cm.

Depth of ploughing

After WW II the standardized ploughing depths in Germany still varied from 12 to 25 cm. A tendency to increase ploughing depths can be discerned: Sommer (1985) noticed that ploughing depth increased by 10 cm in the period 1952-1982.

Van Ouwerkerk (1989) mentions ploughing to a depth of 15 cm attractive as it may result in sufficient weed control. For Sweden, Håkansson et al.(1998) recommend a maximum ploughing depth of 20-25 cm on clay and clay loam soils and on silty soils 15 cm or less. In the last case "perennial weeds should be controlled by other (chemical?) methods". They expect poor weed control, especially of perennials, to prevent continuous use of shallow ploughing. Indeed, shallow ploughing was found to result in more couch grass (*Elytrigia repens*) (Børresen and Njøs, 1994; Pitkänen, 1994) and more *Bromus spp.* (Cussans et al., 1994) than deep ploughing.

Table 1. Effect of tillage method and depth on the incidence of Brome grass (all species) in England and Wales (Cussans et al., 1994)

Method	Headlands (Number)			Field centres (Number)		
	Nil	Weedy	% Weedy	Nil	Weedy	% Weedy
Reduced tillage	13	30	70	28	15	35
Shallow ploughed	4	10	71	9	5	36
Regular ploughed	330	202	38	482	50	9

Table 1 shows the effect of ploughing depth on the incidence of Brome grass. Arlauskas (1987) found after 12 years of ploughing to a depth of 10, 20 and 30 cm, respectively. 9.8, 6.5 and 1.0 g/m² of dry matter of weeds (Kouwenhoven & Boer, 1997).

Populations of perennial weeds have been found to be reduced by deep ploughing (Russell and Keen, 1941; Kropac, 1962). Rübensam and Rauhe (1964) also mention better weed control by deep ploughing. Similar results are mentioned in Table 2.

Table 2. Influence of working depth on the weed population (Kott, 1961)

Working depth, cm	Weed population, n/m ²
20	136
25	61
30	39

So, generally weed populations are negatively related to ploughing depth. Decomposition of weeds covered by ploughing will be easier after shallow ploughing. Also volunteer potatoes are easier controlled by frost, as they stay near the soil surface.

Timing of ploughing; periodicity

Weeds germinate and emerge only when they are in the right position with regard to available moisture and temperature. Germination depends further on viability of the seed and on daylength. During the year weed emergence shows 2 peaks: in spring and in autumn (Van den Brand & Aarts, 1982). Tillage operation in these periods will result in relatively large weed populations.

During summer and during winter only few weeds will emerge, because of shortage of water and low temperature, respectively, together with daylength. The weed controlling effect depends also on soil type, weed type and the weather following the tillage operation.

In The Netherlands ploughing on clay soils is generally carried out before winter, aiming at weathering of the soil during winter, and on sandy soils just before drilling in spring, killing all weeds present at ploughing. Early ploughing on sandy soil resulted in a few large weeds in spring and ploughing in April under normal weather conditions in many, but easy to control small weeds and under dry conditions even less weeds with later cultivation (Table 3).

Table 3. Influence of ploughing time on a sandy soil on the weed population per m², counted at the end of May (Kouwenhoven, 1982)

Year	Weather	Before the end of January	February-end March	April
1978	Normal	131 (83)	157 (100)	
1979	Normal		163 (100)	171 (105)
1980	Dry	84 (115)	73 (100)	56 (77)

6. Conclusions

- Soil inversion by ploughing is important for weed control and for the spatial distribution of weed seeds, nutrients and organic matter
- Weed control is directly and strongly related to ploughing depth.
- Ploughing to the regular depth can be considered as an insurance premium.

Literature

- Aarts, H.F.M. & Van den Brand, W.G.M., 1982. Factoren die van invloed zijn op de grootte en samenstelling van jonge onkruidvegetaties. *Landbouwkundig T.* 94: 235-241.
- Arlauskas, M., 1987. Arimas. Mokslas, Vilnius, Lithuania, 58-59.
- Børresen, T. & Njøs, A., 1994. The effect of ploughing depth and seedbed preparation on crop yields, weed infestation and soil properties from 1940 to 1990 on loam soil in southeastern Norway. *Soil Tillage Res.* 32: 21-39.
- Cussans, G.W., Cooper, F.B., Davies, D.H.K. & Thomas, M.R., 1994. A survey of the incidence of the *Bromus* species as weeds of winter cereals in England, Wales and parts of Scotland. *Weed Res.* 34: 361-368.
- Håkansson, I, Stenberg, M. & Rydberg, T., 1998. Long-term experiments with different depths of mouldboard ploughing in Sweden. *Soil Tillage Res.* 46: 209-223.
- Hoffmann, M., 1983. Bodenbearbeitung im alternativen Landbau. *Landtechnik* 7/2: 55-57.
- Kott, S.A., 1961. Unkräuter und ihre Bekämpfung. Selchosgis, Moscow.
- Kouwenhoven, J.K., 1982. Weed control by tillage tool actions. Proc. 9th ISTRO Conf. Osijek, Yugoslavia: 262-268.
- Kouwenhoven, J.K., 1984. Keren of niet keren, dat is de kwestie. Onkruidag NRLO, Wageningen, pp.6 + tables and figs.
- Kouwenhoven, J.K., 1986. Effect of mouldboard and chisel ploughing and their timing on seedbed quality. *Soil Tillage Res.* 7: 205-219.
- Kouwenhoven, 1998. Grondbehandelingssysteem gebaseerd op minimale ploegdiepte. WAU, Soil Tillage Group, Report 98-2, pp. 24 + 4 ann.
- Kouwenhoven, J.K. & Boer, J., 1997. Minimizing ploughing depth for organic farming. WAU, Soil Tillage Group, pp.39.
- Kouwenhoven, J.K. & Terpstra, R., 1979. Sorting action of tines and tine-like tools in the field. *J.agric. Engn Res.* 24: 95-113.
- Kouwenhoven, J.K., Perdok, U.D., Boer, J. & Oomen, G.J.M., 1999. Five years of soil management by ecoploughing in the Netherlands. Proc. 2nd Inter-Reg. Conf. Enviriment-Water. Lausanne, Switzerland, 1-3 Sept.: 44 + cd.
- Kropac, Z., 1962. Einige Erkenntnisse über den Einfluss verschiedener Pflugtiefen und Pflugverfahren auf die Unkrautbekämpfung in schweren Böden. *Rostl. Vyr.* 8: 139-164.
- Kuipers, H., 1963. Water content at pF2 as a characteristic in soil-cultivation research in the Netherlands. *Neth.J.agric. Sci.* 9: 27-35.
- Kuipers, H., 1975. The objectives of soil tillage. Report IITA, Ibadan: 61-65.
- Kuipers, H., 1981. Mechanical weed control. Int Potato Course, IAC, Wageningen.
- Kuipers, H., 1991. Agronomic aspects of ploughing and non-ploughing. *Soil Tillage Res.* 21: 167-176.
- Pitkänen, J., 1994. A long-term comparison of ploughing and shallow tillage on the yield of spring cereals in Finland. Proc. 13th ISTRO Conf. 24-29 July, Aalborg, Denmark: 709-715.
- Rasmussen, K., 1982. Plant growth and soil physical properties by reduced tillage. Proc. 9th ISTRO Conf. Osijek: 526-531.
- Rübensam, E. & Rauhe, K., 1964. Ackerbau. VEB DLV, Berlin, Germany: 663 pp.
- Russell, E.W. & Keen, B.A., 1941. The results of a six years cultivation experiment. *Studies in soil cultivation X.* *J.agric.Sci.* 31: 346-347
- Sommer, C., 1985. Ursachen und Folgen von Bodenverdichtungen sowie Möglichkeiten zu ihrer Verminderung. *Landtechnik* 40: 378-384.
- Van den Brand, W.G.M. & Aarts, H.F.M., 1982. Eigenschappen van akkeronkruiden. *Bedrijfsontwikkeling* 13: 575-578.
- Van Melick, P.W.H., 1996. Transport van onkruidzaden in de bouwvoor door risterploegen. MSc thesis, Soil Technology Group, WU, pp. 57 + 8 ann.
- Van Ouwerkerk, C., 1989. Experiences with reduced tillage in The Netherlands. In: K. Bäumer & W.Ehlers, (Eds). *Energy saving by reduced tillage*: 41-54.
- Van der Sar, T., 1976. Tillage of dry crops in the humid tropics. *De Surinaamse Landbouw* 24: 93-98.

The Impact Of Harrowing On The Soil-Nitrogen Dynamic Under Spring Wheat - One Year Results From A Loess Soil

Horst H. Steinmann

*Research Center Agriculture and the Environment, University of Goettingen,
Am Vogelsang 6, D-37077 Goettingen
<mailto:hsteinm@gwdg.de>*

In cereal crops, harrowing is considered to be the most important technique of mechanical weeding. As well as effects on weed suppression, farmers appreciate mechanical effects on soil structure, aeration and the enhancement of N-mineralisation. As far as the latter case is concerned, experimental studies are scarce to allow conclusions about the nature and quantity of this process. A field experiment was conducted to study the question whether there is an effect of mechanical weeding on N-mineralisation or not.

Material and Methods

The experiment was carried out in a summer wheat (cv. Tinos, sown at 14. March 1999, 470 kernels m^{-2}) following oilseed rape as a pre crop. The wheat was left unfertilized, but – running in a conventional rotation – the field was N-fertilized during the years before. Chemical weed control was applied to prevent effects due to competition and N-uptake of weeds. Experimental layout was a block design with two treatments (treated, untreated) and 4 replications. Harrowing (= treated) was carried out as follows: 26. April (BBCH-Code of wheat: 13), 4. May (BBCH 21) and 18. May (BBCH 30). Each treatment was conducted as one pass of a hatzenbichler spring tine harrow with moderate velocity (7 km h^{-1}) and nearly maximum strength. Soil type is a deep loess-born soil (13% sand, 72% silt, 15% clay, pH 6,4). Average weather data is: 650 mm a^{-1} rainfall, $8,5 \text{ }^{\circ}\text{C a}^{-1}$. The actual conditions were rather dry during May, unless the monthly sum of precipitation was quite normal. During a time of six weeks following the first treatment in approximately 4-days steps the above-ground biomass was harvested ($0,75 \text{ m}^{-2}$ at each measurement) and soil samples (0-15, 15-30 cm depth) were each taken in the same area of the plot. A subplot of 22 m^2 was kept free from destructive measurements until crop harvest.

Results and Discussion

Only slight differences in NO_3 -content of the top-soil (0-15 cm) were detected (Fig. 1a), whereas hardly any effects of the treatments were found in the layer of 15-30 cm. Plots treated with intensive mechanical treatment in average in 0-15 cm had a higher nitrate content of $0,7 \text{ kg N ha}^{-1}$ during experimental time ($0,95 \text{ kg}$ in 0-30 cm). At single dates, differences of 2 kg N ha^{-1} in maximum were obtained (Fig. 1b).

Kernel yield was unaffected from intensive harrowing, although during experimental time crop biomass production was lower in the treated plots. Thus, higher nitrate contents may be rather due to reduced N-uptake of the crop than to enhanced N-mineralisation. In the viewpoint of plant nutrition the effect of harrowing can be ignored. The experiment is designed to be repeated in 2000.

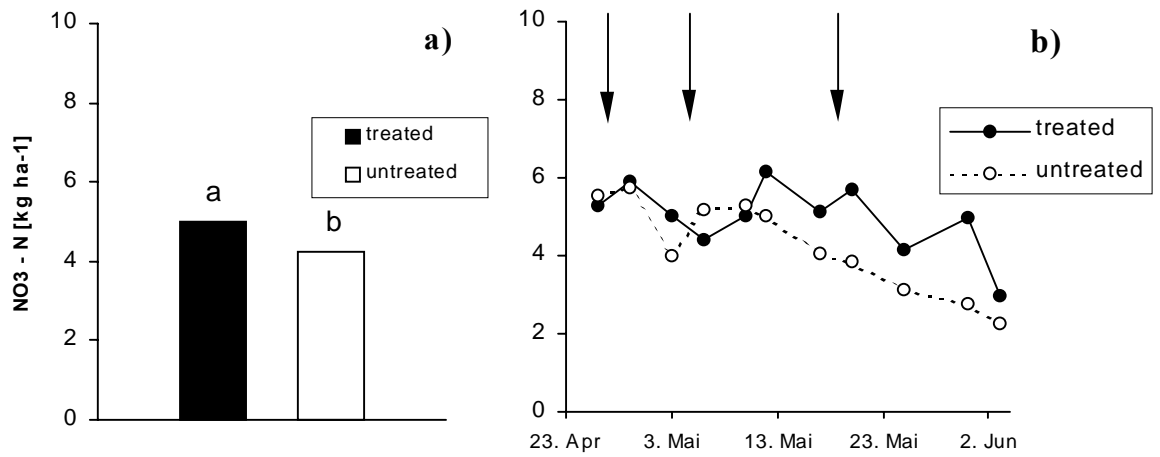

Fig. 1: Soil nitrate-N content in the top soil (0-15 cm) in a summer wheat crop (treated = intensive mechanical weeding, labelled with ↓; untreated = no mechanical treatment). a) average amount of NO₃-N from 26. April to 3. June (LSD= 0,3 kg); b) course of nitrate-N during experimental time.

Mechanical Weed Control In Transplanted Sugar Beet

Bo Melander

Danish Institute of Agricultural Sciences, Department of Crop Protection

Research Centre Flakkebjerg, DK-4200 Slagelse, Denmark

Bo.Melander@agrsci.dk

Introduction

Sugar beet normally require hand-weeding when organically grown. Time consumption for manual weeding may reach more than 150 hours ha⁻¹. Intra-row weeds, i.e. those growing between the crop plants in the rows, are the ones which cause the need for hand-weeding, not those growing between the rows. Several mechanical methods for intra-row weeding in organic sugar beet have been studied in recent years, mainly in Sweden. The work has generally shown that early post-emergence cultivation usually causes severe crop damage using most tools, but later cultivation can be made with a wide range of tools when the sugar beet have developed 4-6 true leaves. However, mechanical methods do not currently form a true solution for an effective removal of manual weeding as it is usually the first flushes of seedlings, emerging within 2-3 weeks after sowing, which are most numerous and thus most time-consuming to remove.

The objective with the present study was to develop a transplantation technique for sugar beet that strengthens the competitive ability of the beet plants and creates favourable conditions for conducting simple and efficient mechanical weeding. The investigations took place on a sandy loam that was under conversion to organic cropping. Two experiments were conducted, one in 1998 and one in 1999. Weed harrowing and torsion weeding were the two mechanical methods under investigation. The sugar beet plants were raised in cylindrical plugs (6 cm long) called *Beekenkamp Bee-Matic* speedlings. They were transplanted in the field in early May when the sugar beet plants had developed 4-5 true leaves.

Results and conclusions

The transplanting technique gave a solid establishment of the beet plants in the soil, which made mechanical weeding possible even 5 days after transplanting. Only torsion weeding at a high intensity (tines 0 cm apart) resulted in severe crop damages at the early treatments. Both weed harrowing and torsion weeding could lower time consumption for hand-weeding to less than 10 hours per hectare without negative yield responses. This was found for weeding strategies consisting of 4-6 passes commenced as early after transplanting as possible and then conducted with short intervals of 5-7 days between each pass. Weeding intensity of each pass was adapted to the prevailing conditions at each time of treatment. Although yield was not affected negatively by mechanical weeding, size and shape of the beets were unacceptable owing to a high degree of forking.

It is concluded that transplanting sugar beet may provide favourable conditions for conducting effective mechanical weeding, however the techniques for raising sugar beet seedlings have to be improved to overcome problems with forking.

Screening experiments and potential use of cover crops in vegetable production

Lars Olav Brandsæter

*The Norwegian Crop Research Institute, Plant Protection Centre, Department of Herbology
Høgskoleveien 7, N-1432 Ås, Norway
<mailto:lars.brandsater@planteforsk.no>*

Abstract

The use of legume cover crops in organic vegetable production is a possible approach for optimizing several factors, e.g. weed control, nutrient supply and pest control. A main concern, however, in e.g. white clover living mulch systems is yield depression due to competition. Screening experiments aimed at finding more suitable cover crops have been initiated in Norway. These experiments have, listed with falling frost resistance, included the following annual or biennial legumes: hairy vetch (*Vicia villosa* Roth.), yellow sweetclover (*Melilotus officinalis* (L) Pall.), crimson clover (*Trifolium incarnatum* L.), black medic (*Medicago lupulina* L.), subclover (*T. subterraneum* L.), barrel medic (*M. trunculata* Gaertn.) and snail medic (*M. scutellata* (L.) Mill.). Experiences of some cover crop systems and suggestions for new systems are discussed in the further: (1) White clover or subclover, established as cover crops in spring, some weeks before transplanting white cabbage have reduced weed biomass in late summer, decreased insect damages, exhibited green manure effects the subsequent year. Disadvantages of this cover crop system is slow ground covering ability in the early season, which decrease the effects on weeds and pests. The biggest problem, however, is yield depression because of competition. There are a need for cover crop species/cultivars which exhibit faster growth (for optimizing weed and pest control) and earlier termination of vegetative growth (for less competition). One possible group to fulfil these objectives is annual medics (*Medicago* spp.). (2) Similar to the experiences of the spring sown cover crop, the benefits and disadvantages are quite similar when establishing the cover crop the year before. However, the cover crop is covering the ground earlier in the summer and the weed and pest control are consequently more promising. Before this system become interesting for growers more efficient clover suppression methods or less competitive cover crops are needed. The use of low growing winter annual legumes, e.g. subclover, is very interesting in this system, but the winter survival of this species is insufficient under Norwegian conditions. (3) transplanting of white cabbage, cauliflower or broccoli into a mowed stand of a winter annual or biennial legume.

A thick layer of e.g. hairy vetch residues has interesting potential for both weed control and green manure effects (Preliminary results: Biomass (dw m⁻²) >600g / >150 kg N ha⁻¹ in late June). (4) Sowing of carrots into a winter annual or biennial legume, e.g. crimson clover or yellow sweetclover, which is mowed later in the season for avoiding competition, may also be a interesting cropping system.

References

- Brandsæter, L.O., J. Netland and R. Meadow 1998. Yields, weeds pests and soil nitrogen in a white cabbage- living mulch system. *Biological Agriculture and Horticulture* 16: 291-309.
- Brandsæter, L.O. and J. Netland 1999. Winter annual legumes for use as cover crops in row crops in northern regions: I Field experiments. *Crop Science* 39: 1369-1379.
- Brandsæter, L.O., T. Smeby, A.M. Tronsmo and J. Netland 2000. Winter annual legumes for use as cover crops in row crops in northern regions: II Frost Resistance Study. *Crop Science* 40:175-181.

Relationship Between The Timing Of Seedbed Preparation And The Efficacy Of Pre-Emergence Flaming

Petri Vanhala

Agricultural Research Centre (MTT), Plant Protection, FIN-31600 Jokioinen, Finland
<mailto:petri.vanhala@mtt.fi>

Abstract

Many weed species have an emergence peak in spring. When flaming weeds prior to crop emergence, the timing is important. The proportion of weeds killed by pre-emergence flaming might be increased by timing seedbed preparation some days before the sowing of the crop. In these experiments we studied the timing of seedbed preparation in relation to sowing date in order to enhance weed emergence and thus improve the efficacy of thermal weed control.

The field experiments were conducted in 1995 and 1996. Seedbed preparation was done with a rotary tiller to 15-20 cm depth either 5–7 days prior to sowing of carrot or at the day of sowing. In both cases, flaming was done 8 days after sowing. Weeds were counted i) on flaming date, ii) 5 days after flaming, and iii) 13 or 21 days after flaming.

When the seedbed preparation was done 5 to 7 days before sowing, more than 75% of the weeds germinated before carrot, and were thus controlled by flaming. Whereas, when the seedbed preparation was done in connection with sowing, only 25–35% of the weeds germinated before carrot. The most abundant weed species in the study were *Chenopodium album*, *Stellaria media*, *Viola arvensis* and *Matricaria matricarioides*.

Manipulating weed emergence by timing seedbed preparation several days apart from sowing gives an opportunity for better weed control by flaming than simultaneous seedbed preparation and sowing. Consequently, need for additional (hand)weeding is reduced. Models and software for forecasting emergence could be used as a further improvement.

Table 1. Timing of seedbed preparation and control effect of flaming in 1995 and 1996

Year	Seedbed preparation	Sowing	Annual weeds (number m ⁻²)			
			On flaming date (14.6.-95 or 5.6.-96)	5 days after flaming	13 days after flaming	21 days after flaming
1995	1 June	6 June	172	16	28	
	6 June	6 June	60	46	57	
1996	21 May	28 May	653	48		194
	28 May	28 May	174	108		458

Effect Of Weed & Crop Variability On Selectivity Of Mechanical Weeders

Dirk Kurstjens



*Institute of Agricultural and Environmental Engineering (IMAG), P.O. Box 43,
6700 AA Wageningen, The Netherlands.*

d.a.g.kurstjens@imag.wag-ur.nl

Introduction

This paper discusses the role of variability between individual plants within the crop or weed population on the ability of mechanical weeders to uproot intra-row weeds with minimum crop loss. This selective ability is required to control weeds in small, weakly established crops. In addition, the role of variability of the implement action (e.g. weed harrow, torsion weeders or finger weeders) is discussed.

The variations we refer to occur within assessment plots of experiments. Variations between assessment plots (flora composition: species, stage, density; soil properties; implement effect & steering variations) are regarded as experimental error, which is dealt with by experimental set-up and statistical techniques. The variations within assessment plots (flora composition: species, stage; spatially heterogeneous implement action) are essentially process-related variations. How to deal with this type of variation?

Selective uprooting of intra-row weeds

A simple case to start with is uprooting action of a weed harrow, torsion weeders or finger weeders. We assume that an individual plant is being uprooted if the force applied by the implement exceeds the anchorage force of that plant. As there is certain variability in anchorage strength, only the weakest plants are uprooted. As crop plants are generally better anchored than weeds, their uprooting probability is lower. If the force applied by the harrow were constant, the uprooting action would be very selective (graph 1). In case of a variable harrow force, less weeds and more crop plants will be uprooted (graph 2).

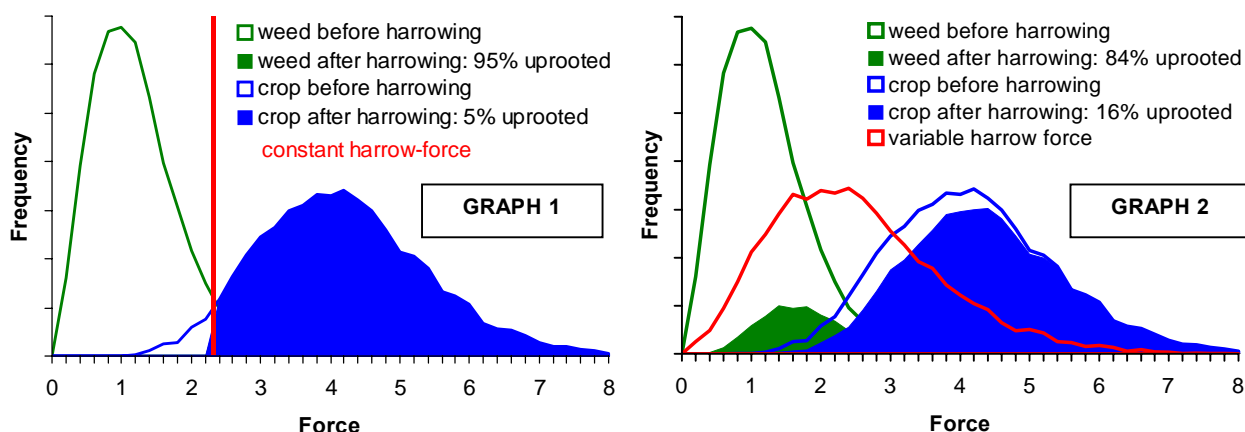

Thus, weeds that are most difficult to control are left to be controlled by a subsequent treatment. This phenomenon could cause a declined efficacy of later treatments. The fact that mainly the smallest crop plants are uprooted could imply a relatively low impact on yield (as compared to sowing density – yield relationships in sowing density experiments). If this were realistic, higher crop losses could be tolerated if the forces applied by the implement are less variable. Moreover, if implement-applied forces are less variable, the mean force could be higher (more aggressive adjustment), resulting in more weed control. Graph 3 shows the simulated relationship between uprooting of the weed and crop population (from graphs 1 and 2), when the mean harrow-applied force is varied (with constant variation coefficient of the square root transformed harrow-applied forces).

Achievable selectivity

The effect of weed and crop variability (identical standard error of square root transformed anchorage forces) on the achievable percentage uprooted weeds at 5% crop loss is simulated assuming a constant harrow-applied force (graph 4) or a variable harrow-applied force (graph 5, variation coefficient of the square root transformed harrow-applied forces = 0.4, which is higher than 0.26 used in graphs 1-3). Graphs 4 and 5 show that more weed control can be achieved if

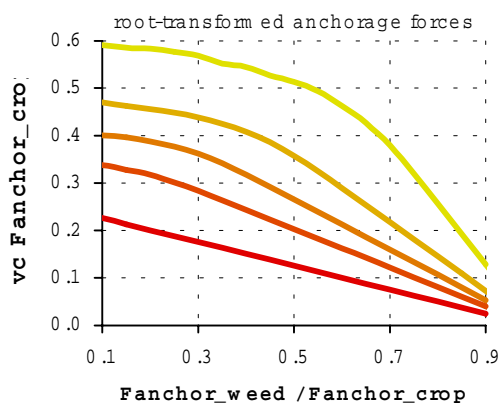
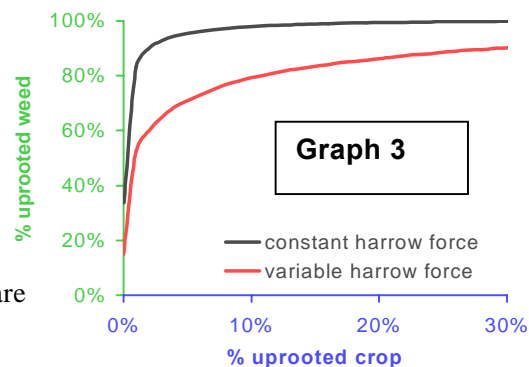

Graph 4

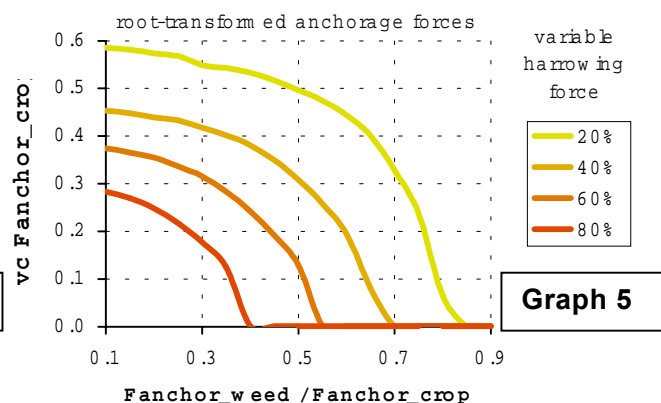

Graph 5

the variation between plants (vertical axis, $vcFanchor_crop$ = standard error of the anchorage force / mean anchorage force of crop plants) is smaller. As the difference between weed and crop declines (moving to the right on the horizontal axis), lower variability between plants is required to achieve the same selectivity. If harrow-applied forces become more variable (graph 4 -> graph 5), the difference between crop and weed anchorage limits the achievable weed control. In case of the example in graphs 1-3 ($vcFanchor_crop=0.15$, $Fanchor_weed / Fanchor_crop=0.5$), the achievable degree of weed control declines from 95% to 60%.

Concluding remarks

The previous examples show that variability between individual plants within assessment plots can influence the result of mechanical weeding. The notion of within-plot variability may have implications for research methodology. There are many questions left to be discussed, such as:

- Is within-plot variation large enough to be relevant?
- What are practical ways to deal with within-plot variation?
- Would it be possible to use the within-weed or within-crop variation to assess the selectivity of intra-row weed control treatments?

If you have thoughts on this matter, please contact me.

Optimising Torsion Weeders And Finger Weeders

Dirk Kurstjens¹ and Piet Bleeker²

¹ *Institute of Agricultural and Environmental Engineering (IMAG), P.O. Box 43, 6700 AA Wageningen, The Netherlands.*



² *PAV Lelystad, P.O. Box 430, 8200 AK, Lelystad, The Netherlands.*

¹ d.a.g.kurstjens@imag.wag-ur.nl ² p.bleeker@pav.agro.nl



This paper presents experiences from experiments in sugarbeets and leek. The effects of steering accuracy, implement adjustments and weed recovery are discussed. We suggest an experimental approach and assessment scheme that could improve our ability to account for several factors that influence the result of mechanical weeding.

Torsion weeders in sugarbeets

When torsion weeding at the 6-leaf stage of sugarbeet on sandy soil, each pair of torsion weeders was adjusted identically. Nevertheless, weed control and sugar beet loss two weeks after treatment varied considerably between sites and between rows, due to differences in the soil disturbance intensity. Intense soil disturbance was associated with higher weed control and higher beet loss (table 1) and weed control and sugarbeet loss were closely related (graph 1). To attain the optimum combination of weed control and crop loss, the torsion weeders should be quickly and accurately adjustable and have improved depth control.

Torsion weeding at the 8-10-leaf stage uprooted 86% of the small weeds and 34% of the large weeds, with only 5% crop loss. The lost beets were relatively small and it was observed that torsion weeders could flex around the sugarbeets. So, the whole intra-row zone could be loosened intensely to a depth of 2.5 cm. After two weeks, only 0 to 17% weed control was achieved. Apparently most of the uprooted weeds recovered, despite the four dry but clouded days after treatment.

In laboratory weeding experiments, mortality of uprooted seedlings strongly depended on the soil moisture content at harrowing, whereas covering hardly killed any plants. When ridging sugarbeets before canopy closure, the 3-5 soil cover was equally effective at dry circumstances or at 11 mm artificial precipitation applied directly after ridging. Therefore, combining assessments directly after weeding and before the next weeding provides insight in the potential and the weather-dependent actual effect, especially when uprooted, covered and undamaged plants are discerned.

Table 1	plant loss at 6-leaf stage			
	soil disturbance	sugarbeet	small weeds	big weeds
1		1.4%	47%	6%
2		1.1%	56%	33%
3		5.8%	75%	18%
		5.6%	76%	33%
significance	p<0.001	p<0.001	p=0.057	

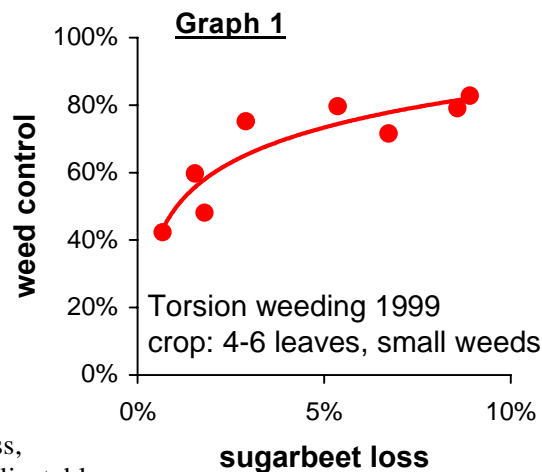

Torsion weeders and finger weeders in transplanted leek

Three weeks after transplanting, leek plants were firmly anchored in the sandy soil, due to heavy rainfall. Even aggressive weeding with torsion weeders and finger weeders (adjustments see table

	working depth (cm)	overlap (cm)	speed km/h	weed control
Torsion weeders smooth	2.4	1.5	5	59%
Torsion weeders aggressive	2.7	5	8	81%
Torsion smooth + 2*finger	1.9	1.5/3.5	5/10	79%

2) did not cause any crop damage. When torsion weeders were adjusted backwards with tine-points pointing downwards (see photo), they were able to flex around the leek plants and uproot nearly all intra-row weeds. The more aggressive action of the torsion weeders improved weed control (assessed after one week).



In loose soil, finger weeders were not able to significantly move soil and weeds from the row, because of lacking slip of the rubber fingers. Nevertheless, finger weeding twice after torsion weeding improved weed control. Without torsion weeding, finger weeders could not penetrate the compact soil, which impedes weed control.

Experimental approach

Without accurate steering and implement adjustment, the weed control potential of intra-row weeders such as torsion weeders and finger weeders will be underestimated. Therefore, the most accurate implements available should be used. When several weeders are to be compared, mounting them side-by-side on the same machine reduces the impact of steering errors, as all implements have the same error when operated simultaneously.

Furthermore, implements should be compared at a comparable level of crop damage, preferably the “optimum” combination of weed control and crop damage. As a comparable level is difficult to achieve and the optimum is not straightforward, we suggest using two levels of aggressiveness per implement. The “smooth” adjustment aims to achieve maximum control at a near-zero crop damage. The “aggressive” adjustment aims to achieve either 100% weed at minimum crop damage or maximum weed control at the maximum tolerated plant loss (e.g. 20%). The optimum adjustment is inbetween these extremes, but depends on the trade-off between cultivation costs, handweeding costs and yield loss.

Suggested assessments

In future experiments we try to account for factors that influence the weeding effect, by performing a set of assessments:

- Working depth and soil upheaval in the crop row, measured by 30 cm PVC sticks with a carve in the middle. Before cultivation, sticks are pushed into the soil with the carve level with the soil surface. After cultivation one can easily measure soil level upheaval and (after excavating the tilled soil) working depth.
- Immediate (at the day of cultivation) and final (before the next cultivation) weed control effect. When assessing the immediate effect, discerning types of damage (1: uprooted, both visible and covered; 2: covered but not uprooted; 3: not covered and not uprooted) provides valuable information in evaluating the effect of weather after cultivation.
- Defining a narrow intra-row counting zone, which has the same width before and after treatment is essential to discern the effect of hoeing (between rows) and the selective intra-row action. For example, the 40% weed control at 0% beet loss in graph 1 could be due to the narrowing of the counting zone. Instead of counting the number of weeds on a fixed counting plot area, we assessed the

length of the intra-row strip that contains 50 plants. This method makes the accuracy of weed density assessments independent of the density itself. It is practical when weeding is very effective or when weed densities are low.

As these improvements are only suggestions and do not provide “the ultimate methodology”, we would like to discuss with other researchers to improve our field experiments. So, if you have thoughts on this matter, please contact us.

Can Slurry Injection Improve The Selectivity Of Weed Harrowing In Cereals?

Karsten Rasmussen

*Danish Institute of Agricultural Sciences, Department of Crop Protection, Research Centre
Flakkebjerg, DK-4200 Slagelse, Denmark*

Introduction

Rasmussen (1990) defined the selectivity of weed harrowing as the ratio between weed control and crop damage. Weed control was measured as percentage weed density reduction and crop damage as percentage soil cover of the crop. It is desirable to have a high selectivity at the time of operation, and the selectivity is determined by the relative size of the crop and the weed plants. Slurry injection was seen as a possibility to improve the selectivity. Slurry served below and close to the crop seeds was expected to improve crop growth relative to weed growth due to shorter distance to the nutrient (Figure 1). This was expected to make crop plants more resistant and weed plants less resistant to weed harrowing, and consequently the selectivity should be improved. Furthermore, increased selectivity correlate to increased competitiveness of the crop against weeds surviving the weed harrowing.

Figure 1.

Slurry injection in every
second row of a cereal crop.

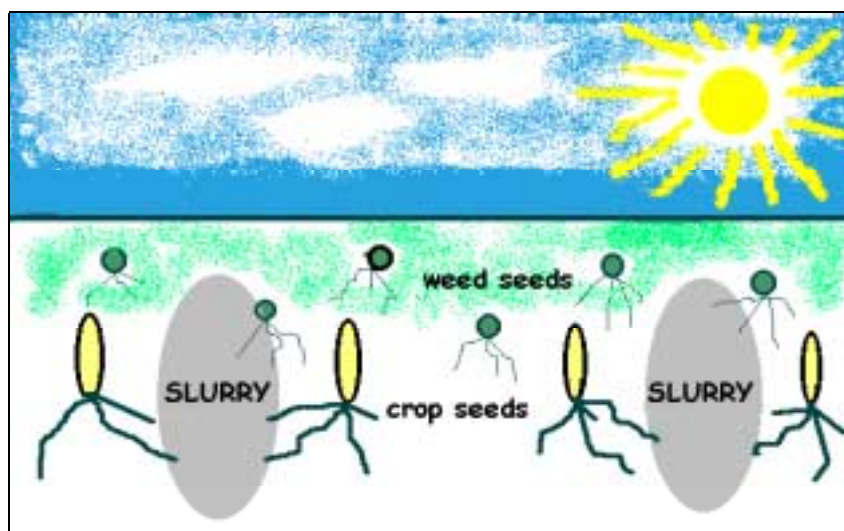

Methods

The effect of the animal slurry application method on selectivity of weed harrowing in spring oat was investigated in field experiments over three years. Slurry injection in every second row (Figure 1) was compared to surface application in oat, with a range of intensities of harrowing obtained by increasing speed at growth stage 12 – 13 (BBCH). 20 tons of slurry with an $\text{NH}_4\text{-N}$ content of approximately 80 kg ha^{-1} was applied. Weeds were counted 5 – 6 weeks after harrowing. Spectral reflectance measurements (Christensen & Goudrian, 1993) were carried out before and after harrowing to estimate the crop cover from the relative vegetation index.

These experiments are contrasted to another experiment including the same slurry application methods. In this experiment barley and oat were compared in untreated, harrowed (pre-, post- and late post-emergence) and herbicide treated plots.

Results

In two out of three years, the selectivity was not influenced by the manure application method in oat. In the third year, the selectivity was increased by the injection of the slurry i.e. the weeding effect was doubled at equal crop soil cover. A tentative explanation was found in the comparison of barley and oat in the last experiment. Sown on the same day, barley emerged one or two days prior to the oat, and its growth (relative vegetation index) was ahead of the oat until about 45 days after sowing. After this, the oat had a

higher vegetation index than the barley. In the first period barley showed significantly increased growth response to slurry injection, while oat did not respond to the application method until approximately 45 days after sowing. After this date, injection of slurry also increased the growth of the oat significantly. This explains why sensitivity of harrowing at growth stage 12 – 13 (30 days after sowing) was not clearly influenced by the slurry application in the oat. On the contrary, the effect of weed harrowing (three times) in barley was significantly improved by slurry injection.

Conclusions

Yes, slurry injection can improve the selectivity, but not at all circumstances. Crop species and probably also varieties and weed species react differently to locally placed nutrients, which explain varying results. Further knowledge about early growth of crops and weeds might improve the potential of locally placed nutrients as a method to increase selectivity of weed harrowing.

References

- Christensen S & J Goudriaan (1993). Deriving Light Interception and biomass from Spectral Reflectance Ratio. *Remote Sensing of Environment*, 43:87-95.
- Rasmussen, J. (1990). Selectivity – an important parameter on establishing the optimum harrowing technique for weed control in growing cereals. *Proceedings of the EWRS Symposium, Integrated weed management in cereals: 197-204.*

Perspectives Of Mechanical Weed Control In Ryegrass Seed Crops.

Gerard Borm, Rommie van der Weide and Henk Floot

Applied Research for Arable Farming and Field Production of Vegetables (PAV)

P.O. Box 430, 8200 AK Lelystad, the Netherlands

G.E.L.Borm@pav.agro.nl

Abstract

In five trials on sand or peat and in three trials on light clay soil the effects of different row distances and weed control methods for perennial ryegrass (*Lolium perenne* L.) were investigated. In crops of Westerwold ryegrass (*Lolium multiflorum* Lam.) three trials with row distances and weed control methods were conducted on a light clay soil. The row distances tested were 12.5, 25, 37.5 and 50 cm. Weed control methods included in these trials were: no weeding, hand weeding (both only on sand), chemical, harrowing, hoeing, hoeing + harrowing, flexible (chemical + mechanical, only on clay) and row spraying + hoeing (only in perennial ryegrass on clay at a row distance of 50 cm).

In the trials in perennial ryegrass on sand or peat the increase of row distance resulted in a small decrease of seed yield which was significantly lower only at a row distance of 50 cm. On the clay soil there was no effect of row distance on seed yield. In Westerwold ryegrass seed yield at a row distance of 12.5 cm was significantly lower compared to the other row distances.

Due to weather circumstances it was not always possible to control weed mechanically in autumn. Harrowing in young crops of ryegrass harmed the crop more at a narrow row distance but didn't result in a significant decrease of seed yield. The other mechanical weed control methods did not affect the crop clearly. Crop damage was observed in two of the three trials on the light clay soil by the application of ethofumesate in the late autumn at a rate of 1.5 kg active ingredient per ha which increased with decreasing row distance. This rate is necessary to control black grass (*Alopecurus* L.) completely.

The effectiveness of the different mechanical weed control methods was sufficient in the situation of a low weed pressure on sand. On clay soil in perennial ryegrass seed crops control of black grass and scented mayweed (*Matricaria chamomilla* L.) was not acceptable in the situation of only mechanical weed control. Contamination of the cleaned seed with seeds of black grass did not reach quality standards. In Westerwold ryegrass seed crops only harrowing could not control redshank (*Polygonum persicaria* L.) sufficiently.

By the combination of chemical and mechanical weed control (flexible, row spraying + hoeing) it was possible to reduce the input of active ingredient of herbicides considerably. In seed crops of perennial ryegrass there was no loss of quality or financial yield. In Westerwold ryegrass there was a small decrease of financial yield in the situation of this (flexible) weed control method.

Soil Treatment For Preventive Weed Control Without Increasing The Erosion Hazards

Reidar Holmøy and Einar Teslo

Department of Agricultural Engineering, Agricultural university of Norway

Abstract

Soil tillage, particularly ploughing, is perhaps one of the most important methods for preventive weed control. However, recent research has also shown it to be one of the major causes of soil erosion. This contrast is a great problem for environmentally friendly agriculture and formed the background to the project: «Soil treatment systems for preventive weed control in ecological agriculture» at our Department. The project consisted of four, two or three years, large field experiments concerning preventive weed control and erosion under different growing conditions on erosion exposed soil types ranging from sandy loam to silty loam and clay loam. Experimental treatments were main soil tillage before sowing with 9, 10 or 11 methods and post harvest stubble treatments with two methods. Cereals were grown on all fields except one with grain fodder in one of the years.

The main results from the project concerning weed control and yield of grain were as follows:

- Main soil tillage by means of ploughing (depth 12-14 cm or 20 cm) in general gave better weed control and better grain yield than did preparation by means of harrowing with a tine cultivator with «duckfoot» shares, a rotary spike cultivator or a rotary harrow (depth 10 cm)
- However post harvest stubble treatment in the autumn by stubble cutting (cutting the cereal stubbles and the weed) or by means of stubble harrowing with a tine cultivator with «duckfoot» shares (depth 7 cm), mostly increased the weed efficiency and the yield for the main soil preparation by harrowing. This interaction more or less compensated for the difference between ploughing and harrowing.
- Totally, stubble harrowing was better than stubble cutting. Later investigations however, indicate that stubble cutting just after harvesting and 4 weeks later may give better weed results than only one stubble cutting 4 weeks after harvesting, such as we did in the project.
- As a whole, no significant difference in weeding efficiency and grain yield were found between ploughing in autumn and ploughing in spring, between deep (20 cm) and shallow (12-14 cm) ploughing, between using a soil packer after the plough or not, or between using sub shares under the ploughs or not. Not either were in general found significant difference between the above reported harrowing tools for the main soil preparation in the spring.

The conclusion is that for erosion exposed soils, where spring tillage therefore is advised under Norwegian conditions, ploughing deep or shallow in the spring and spring harrowing combined with stubble treatment in the autumn, to a certain extent, will give satisfactory weed control and yield. From before we know that ploughing in spring on heavy clayey soils mostly gives a low yield under Norwegian conditions, but also that we may well continue to plough such soils in autumn without running any unacceptable erosion risk.

Susceptibility of Sweet Maize (*Zea mays*) to the Rotary Hoe: Preliminary results

Daniel Cloutier¹ and Maryse L. Leblanc²

¹ Researcher, Institut de malherbologie, P.O. Box 222, Sainte-Anne-de-Bellevue, Québec, Canada H9X 3R9;

² Researcher, Institut de Recherche et de Développement en Agroenvironnement, P.O. Box 480, Saint-Hyacinthe, Québec, Canada J2S 7B8
daniel.cloutier@videotron.ca and maryse.leblanc@irda.qc.ca.

Introduction

Mechanical weeding of corn usually requires two weeders, one to weed at the beginning of the season and a second to weed between crop rows later in the season when the crop is more developed. Inter-row weeding is generally well established. However, weeding at the beginning of the growing season is more problematic. Weeds that become established during this period can cause considerable loss and therefore, must be removed as early as possible both on and between rows. One of the rare weeders currently available that can perform this task is the rotary hoe. The rotary hoe can cultivate 2 to 4 times faster than a regular inter-row weeder and so save time and money. It is most effective when it is used on germinating weeds prior to emergence or at the cotyledonary stage. However, there is the possibility of damage to the crop since the rotary hoe cultivates on the row.

Sweet corn can tolerate some cultivation by the hoe. However, a systematic study to identify the susceptible growth stages has never been performed. This information is essential to develop mechanical weed control programs that will aid producers in the management of their crops.

The objective of this project is to determine the susceptibility of various growth stages of sweet corn to physical damage caused by cultivating with the rotary hoe. It is likely that there is a difference in susceptibility between varieties and, consequently, the management of mechanical weeding should be adapted to the variety. The project studies the response of three varieties of sweet corn: early, mid-season and late-season to cultivation.

Results

- Sweet corn can be cultivated with the rotary hoe at any growth stage, from pre-emergence to 6th leaf. The 1 leaf stage appears slightly more susceptible to cultivation damage than the other growth stages studied in this project but yield was not affected.

- Sweet corn yield was not significantly decreased by up to four cultivations in four of the five experiments in this project. Cultivations only decreased yield in the mid-season corn of the second seeding date.

- One, two or three cultivations with the rotary hoe were beneficial to the crop and, in the absence of weeds, this is probably due to breaking the soil crust and/or decreasing insect damage.

- Late-season corn suffered slightly more damage by cultivation and had more insect damage than the other types of corn in this project.

- The type and condition of soil could play an important role in the susceptibility of corn to cultivations with the rotary hoe. Risks of crop damage increase with dry light soils. Seeding in light soil should be as deep as possible in order to minimize the risks of damaging the corn.

Susceptibility of Dry Edible Beans (*Phaseolus vulgaris*, Cranberry Beans) to the Rotary Hoe

Maryse L. Leblanc¹ and Daniel Cloutier²

¹Researcher, Institut de Recherche et de Développement en Agroenvironnement, P.O. Box 480, Saint-Hyacinthe, Québec, Canada J2S 7B8

²Researcher, Institut de malherbologie, P.O. Box 222, Sainte-Anne-de-Bellevue, Québec, Canada H9X 3R9;

maryse.leblanc@irda.qc.ca and daniel.cloutier@videotron.ca

Abstract

A three-year study was conducted to assess cranberry bean susceptibility to mechanical weeding using the rotary hoe at pre-emergence, hook, cotyledons, unifoliate, first to fourth trifoliate stages of bean development and at different combination of stages. Cultivation with the rotary hoe did not reduce bean grain yield except for the treatment which received four cultivations at different bean growth stages. Three cultivations improved yield compared with the check without cultivation. Single cultivation done at any of the crop growth stages did not affect grain yield. Crop density at harvest was significantly decreased by 6 % in the treatments receiving two cultivations and by 9 % in the treatments receiving four cultivations compared with the control. The effects of the cultivations on grain moisture were not consistent and differed year from year. Seed weight did not differ among treatments in either year. Since this project was conducted under weed free conditions, the beneficial effects of cultivating with the rotary hoe are probably mostly related to breaking the soil crust, to improving soil aeration, to preserving soil moisture or to promoting mineralization of the nutrients required by crop.

Susceptibility of Row-Planted Soybean (*Glycine max*) to the Rotary Hoe

Maryse L. Leblanc¹ and Daniel Cloutier²

¹Researcher, Institut de Recherche et de Développement en Agroenvironnement, P.O. Box 480, Saint-Hyacinthe, Québec, Canada J2S 7B8

²Researcher, Institut de malherbologie, P.O. Box 222, Sainte-Anne-de-Bellevue, Québec, Canada H9X 3R9;

maryse.leblanc@irda.qc.ca and daniel.cloutier@videotron.ca

Abstract

A three-year study was conducted to determine soybean susceptibility to physical damage from cultivations done with the rotary hoe in a weed-free situation. Plot size was large enough to enable the rotary hoe to be used at a speed of 15 km h⁻¹. The soybeans were systematically cultivated at eight growth stages, from pre-emergence to fourth trifoliolate leaf. Two, three and four cultivations were done on a combination of growth stages. Soybean population decreased with the number of cultivations but yields were either not affected or significantly increased compared with the uncultivated control. Cultivations with the rotary hoe could be done up to the 4th trifoliolate leaf growth stage without risk of decreasing yield.

Cutting Weeds With CO₂ Laser – Preliminary Results

Torben Heisel & Svend Christensen
Danish Institute of Agricultural Sciences, Department of Crop Protection
Research Centre Flakkebjerg, DK-4200 Slagelse, Denmark
Torben.Heisel@agrsci.dk

Background and method

Cutting with a CO₂ laser is an alternative physical weed control method. Lasers are e.g. used for industrial cutting of iron, textile and wood, for medical surgery and for sample preparation in microscopy. A laser concentrates large amounts of energy in a thin beam and can be directed precisely and quickly. Furthermore the laser beam can be focused in a narrow area to increase the energy in focus and decrease danger outside of focus. The objective of this preliminary study is to investigate re-growth of *Chenopodium album* L. and *Sinapsis arvensis* L. three weeks after cutting, as a function of an increasing CO₂ laser energy at three different growth stages.

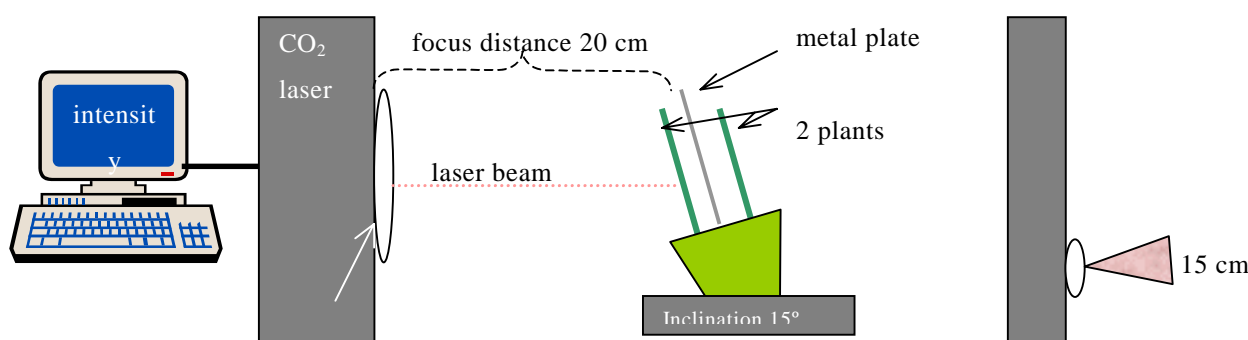

Laser cutting arrangement with control computer, CO₂ laser (10600nm) and pot holding device seen from the side (left) and above (only laser and beam) (right).

Results and perspectives

Dry weight of re-growing tissue versus used energy showed an expected dose-response relationship. At all growth stages *S. arvensis* was more tolerant than *C. album* to CO₂ laser cutting. Approximately 2 J/mm seemed to be sufficient CO₂ laser energy to significantly reduce re-growth of *C. album* and *S. arvensis*. The results show that CO₂ lasers have the potential of being used as a cutting device for physical weed control. The approach could be as a precision guided tool used to cut weed seedlings close to the crop plant at the very early growth stages. Another application could be as a mower tool to control weed on roadside or pavement, decreasing the need for precision guidance, hence probably increasing energy consumption. More research in areas that investigate total energy costs is called for.

Mechanical Weed Control Using Inter-Row Cultivation and Torsion Weeders In Vining Pea

Johan Ascard¹, Nina Olstedt¹, & Håkan Bengtsson²

¹ Swedish Univ. of Agric. Sci., Dept. of Horticulture, Box 55, SE-230 53 Alnarp, Sweden.

² Findus R & D, Box 530, SE-267 25 Bjuv, Sweden

Conventional farming practices in vining pea (*Pisum sativum* L.) for producing frozen peas, involves broadcast drilling at 12 cm row spacing and chemical weed control. Good weed control is important to obtain a high quality product, i.e. it must not be contaminated with flower buds from weeds, especially *Matricaria* spp. and *Cirsium arvense*.

The general purpose of this project was to find rational methods for mechanical weed control in vining peas due to the increased environmental awareness and the demands for organically produced food. Earlier research at Nestlé R&D Center (Kudsk, 1997) showed that weed harrowing controlled weeds in vining peas but caused too much crop damage.

Five field trials were conducted in southern Sweden during 1997. The purpose was to compare time of hoeing (early, late and early + late) and the effects of torsion weeders as an additional tool. The row spacing was extended to 25 cm to allow for row crop cultivation. The row crop cultivator was a modern front mounted 10-row Hatzenbichler. The torsion weeder consisted of one pair of 9-mm spring tines per row, working close to the row. The mechanical treatments were compared to an untreated control and to a standard chemical weed control using an early post-emergence application of bentazon 290 g ha⁻¹ and aclonifen 450 g ha⁻¹.

Mechanical and chemical weed control produced similar pea yields and weed numbers, but weed biomass was greater with mechanical control. One, late hoeing when weeds were 5-10 cm tall and peas had 4-9 nodes generally controlled weeds better than one early hoeing when weeds were in the cotyledon stage and peas had two nodes. Two cultivations, early and late, only slightly enhanced weed control compared with one late treatment. Therefore it is not economically justifiable to cultivate twice. The costs of one row crop cultivation is similar to one herbicide treatment.

Row crop cultivation with torsion weeders gave slightly better weed control than ordinary row crop cultivation in some but not all experiments. The reason for this low additional effect was probably that the hoe did a good job leaving few weeds for the torsion weeders to control. The hoe had only a 7 cm gap between the cultivator shares. In addition the cultivator covered some of the in-row weeds with soil.

Although the biological effect of the mechanical weed control was acceptable in these small plot trials there are some technical problems that have to be solved before adoption in large scale pea production. A guidance system has to be developed and the capacity of the cultivator needs to be increased. Additionally, the row spacing needs to be wider than 25 cm where the tractor wheels run since there was severe damage in rows adjacent to the tractor wheels. In conclusion, row crop cultivation is a promising method in peas but the technique needs further development.

A list of references cited is available on request.

Selective Flaming - Fundamental Measurements And Practical Use

Reidar Holmøy¹, Kai J. Storeheier¹ and Leif-Trygve A. Berge²

¹Department of Agricultural Engineering, Agricultural University of Norway.

²The Ecological Research and Extension Group in Hordaland, Norway

Energy, lethal time and lethal temperature

Our fundamental work concerning flaming, dealt with three basic laboratory investigations, and more two years dose-response field experiments with selective flaming at Hordaland and the university fields at Ås. **The main conclusion of the laboratory experiments on effect of flames on the plants is a confirmation of the general energy equation: Energy = ?(Temperature × time × constant) and also is true for these very high temperatures, and further that, at lower temperatures, more energy is needed to kill plants than at high temperatures (fig. 1).** If the constant is 1, we get :

“Sum of heat” (as an expression of energy) = ?(Temperature × time) (Storeheier 1991).

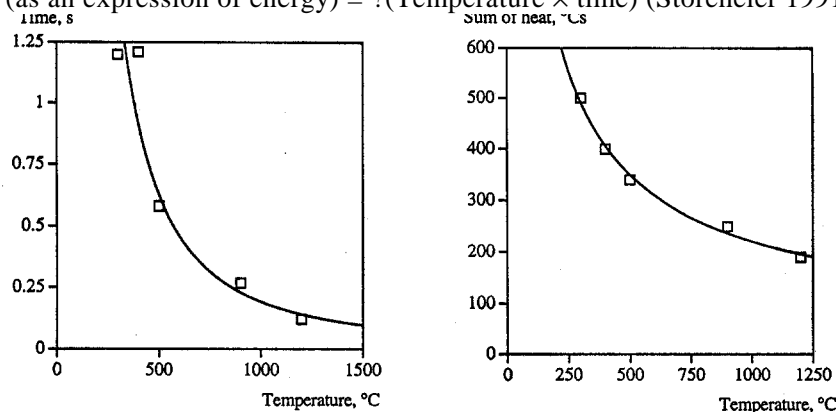

Figure 1. Left. Relationship (mean values) between lethal time and lethal temperature from laboratory flaming experiments, calculated according to a regression equation developed by Storeheier (1991) after studies of papers from, amongst other, Ryan, Joiner and Ryan (1985) and Sutcliffe (1977). Plants used in the experiments were: Chrysanthemum, spinach, carrots, cauliflower, oil-type turnip rape. Right. The same material as the left hand figure, recalculated to show relationship between lethal temperature and lethal sum of heat. (Storeheier 1991)

Temperature recordings into the the flames from stationary burners



Figure 2: Temperature recordings in the flame impact zone on the soil surface from a round Sievert shaped burner with a long and narrow flame (left) and from a flat shaped ITF burner with a short, wide, and rather thin flame (right). The glowing thermocouples, at 3 cm mutual distance in the row, are seen in the ends of the airborne flames.

Fictitious grids were made (fig. 3). For the flame on the ground, the burner was moved in horizontal steps of 10 cm against the thermocouples for stationary measuring (fig. 2). For the airborne flame, a bar with the thermocouples was moved in vertical steps of 3 cm in front of a fixed, horizontal burner. These steps made the length-way sides of meshes on the grid, while the rows of thermocouples made the cross-way sides. Table 1 show that high temperature is achieved by keeping a short distance between the burner and the plants. Increased gas throughput raised the temperature only at distances larger than 10 cm from the burner.

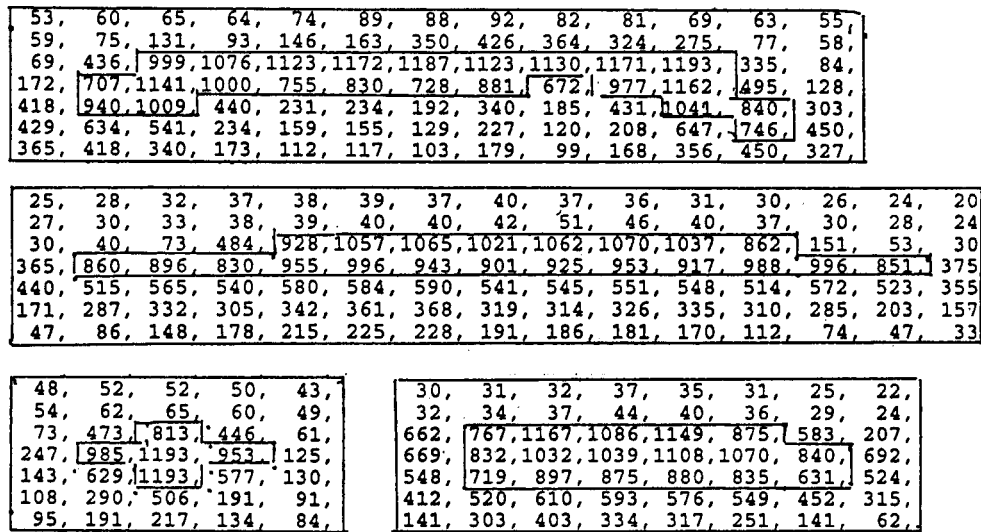

Figure 3. The fictitious grids with the temperature recordings expressed as isotherms of 700 °C Pressure 2 bar. Above. Measuring in the ITF airborne flam. Mid. Measuring in the ITF ground impact zone. Below. Measuring the Sievert airborne flame (left) and ground zone flame (right).

Table 1. Survey of the results inside the isotherms for the ITF and the Sievert burners as maximum temperatures, and as max. width and thickness of the flame cores in the air (top) and of the flame zone on the ground (below). Variables were different distances between burner and thermocouples or at different burner angles to the ground. (Holmøy, Storeheier, Berge, 2000)

Burner make	Burn.-shape	No-zle mmØ	Gas-cons. kg/h	Max. temp., °C at distance, cm			Max width core At distance, cm			Max thick. core at distance, cm		
				10	20	30	10	20	30	10	20	30
ITF	Flat	1,0	2,3	1193	896	564	33	21	-	12	12	-
ITF	Flat	1,4		1250	1152	877	33	36	12	9	9	9
Sievert 2954	Round	0,8	1,3	1193	1161	989	9	9	9	9	9	6
Sievert 2959	Round	1,2	3,7	1082	1118	1082	9	12	12	12	15	18

Burner make	Burn.-shape	Noz-zle mmØ	Gas-cons. kg/h	Max temp. °C at burner angle			Max width cm at burner angle			Max length cm at burner angle		
				22,5°	45°	90°	22,5°	45°	90°	22,5°	45°	90°
ITF	Flat	0,7	1,2	737	1189	1201	6	30	30	10	20	20
ITF	Flat	1,0	2,3	873	1070	1191	24	39	36	20	20	30
ITF	Flat	1,2	3,4	1125	1176	1146	33	48	39	30	40	40
Sievert 2954	Round	0,8	1,3	1073	1167	1109	9	18	24	30	30	30
Sievert 2959	Round	1,2	3,1	1106	1036	968	18	27	27	50	40	30

It seems as if the Sievert 2954 and 2959 may have been changed in the experiments on the ground zone.

Measurements into the ground flame zones from burners mounted on a moving flamer

Figure 4 left, shows that the round burner is more efficient than the flat one at small burner angles and less efficient at bigger angles. That must be due to the differences in length and widths of these flames as shown in table 1 and figure 2. A long and narrow flame will reach longer at small angles, but will also cover a narrower row of thermo-couples at larger angles than a short and wide flame. Figure 4 mid and right explains the importance of both long and low shields to get the flame near to the ground for a long time, and the importance of getting enough oxygen for the combustion. The shields used in the experiments here did not have sloping roofs, which we now advice as an consequence of these

results, as shown in figure 5 left. Short, wide and thin flames are favourable in selective in-the-row flaming with flat, open, and inclined burners. Then the flame hits the ground at only 8 to 10 cm distance from the burner muzzle and we only want the about 20 cm long, 'hot core' in the flame sweep (fig. 2 and 3 and table 1).

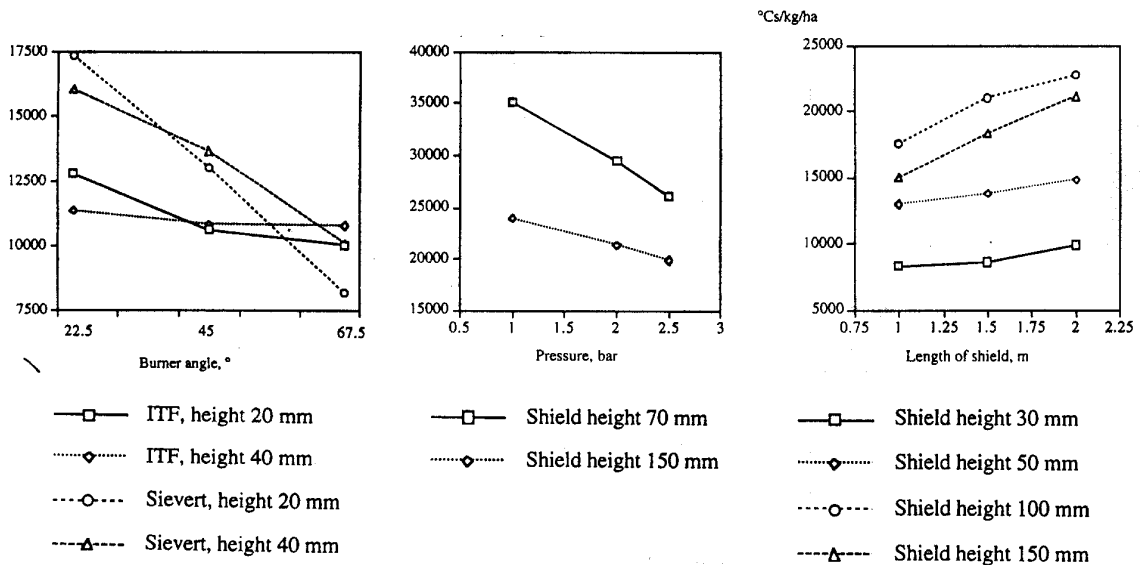

Figure 4. Relative utilization factor ($\frac{??T \times t}{G} = \text{Cs/kg gas/ha}$) (Storeheier 1991) Left. Sievert and ITF burners, unshielded and with different burner heights and mounting angles relative to soil surface. Middle. Mean results for the two burner types at different shield heights and gas pressures. Right. Mean results for different shield heights and shield lengths. (Storeheier 1993)

Field experiments

The methods for practical flaming in the field are illustrated and explained in figure 5. Further the results of the dose-response field experiments at selective flaming are shown in figure 6 and 7 and table 2. The effect on both weeds and crop plants was clearly increasing with increasing doses. On the weeds the increase however, generally diminished for doses above 70 kg/ha. The best and most certain results were obtained in onions, white winter cabbage, autumn cabbage, and broccoli. Also summer cabbage, cauliflower, swedes, red beets, and the two celery's came fairly well off. But especially in stalk-celery the results were somewhat uncertain. Generally the highest rate of damage appeared after the first flaming, mostly as burned patches. The second flaming caused less damage, and the late assessment showed that the middle-dose crops had increasingly recovered from the burns. Besides, the crop plants after smaller doses were restrained by the now taller weeds. As a consequence of all this, the assessed dose-response curves at this late stage assessments («Plant 3» in fig. 7 and «Ass. 3» in table 2), are rather similar to the yield curves, mostly culminating at gas-doses of 50-90 kg.

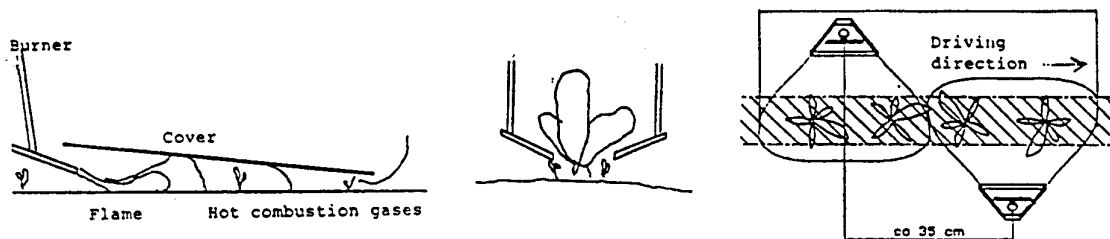

Figure 5. Left: Ordinary none-selective flaming under cover, which may also be tried for selective flaming in fields with very heat-tolerant cultivated plants. The flames and the combustion gases are forced downwards by the 150 cm long and sloping cove. According to the equations for energy, the flame and the hot combustion-gases should be in contact with the weeds for a long time. Here, this contact-time is equal to the driving-time for a distance of 150 cm. The

average temperature under the cover is about 650 °C. To also get enough oxygen for the combustion, the cover is higher in front than behind (8-3 cm). Middle: Selective flaming in the plant rows with two open, inclined ITF- burners. Transversal distance between burner muzzles ought to be about 25 cm. The arrangement here is also illustrated in fig 2.,but here the thermocouples are replaced by the crop plants and the driving direction is along the rows. Right: The same as in the mid-figure, seen from above. According to the measures of distance between the burners in this figure, and the information from figures 2 and 3, the flame sweep on the ground from each of the burners will form a hot core of about 30 x 20 cm in the plant row. The cores follow each and so we get an continues treatment time similar to the driving-time for a distance of 60-70 cm and a average temperature of about 900 °C

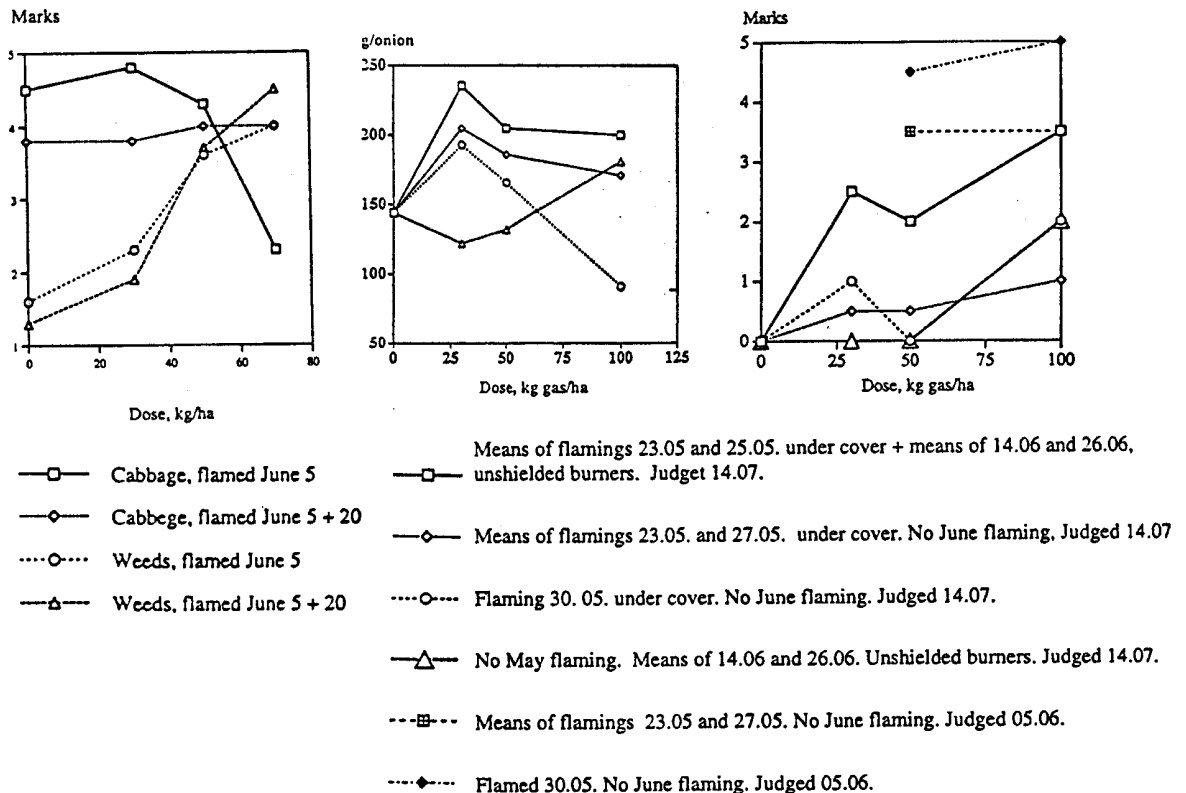

Figure 6: Effects on crop plants and weeds of selective flaming in fields at Ås, with transplanted cabbage and onions grown from sets. Grading marks: 0-5 = very large-negligible amount of weeds or degree of damage and growth-restraint. Left. Cabbage field, assessed a few days after the 1. and 2. flaming. Middle. Effects on onion plants. Right. Effects on the weeds in the same onion field (Holmøy, Netland and Balvol-(1993), Holmøy and Storeheier (1995.))

An exception from the results described above is the onions curves from Ås, (fig. 6) culminating already at dose 30 kg/ha as compared to the culmination at dose 70-90 kg/ha in Hordaland (fig. 7). The main reason probably was that shielded, selective flaming, which was used at the first flaming in Ås, gives no protection to the "heart leaves" of the crop plants, as the inclined flat burners method, used in Hordaland, does.

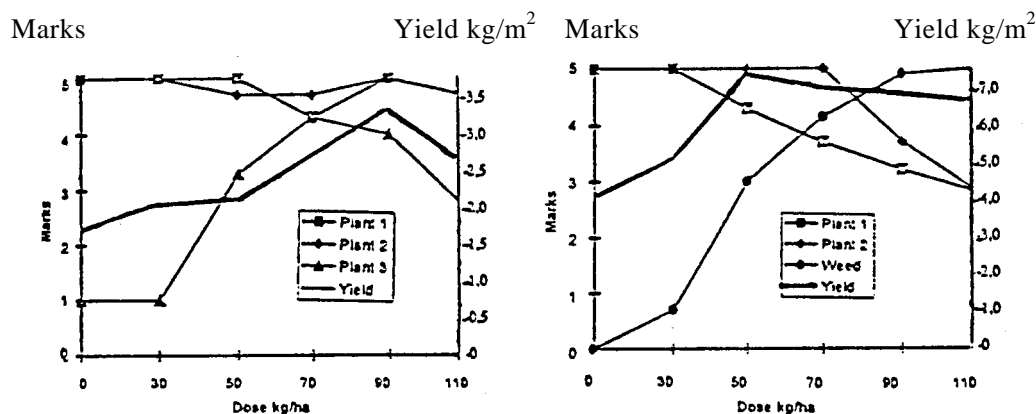

Figure 7: Examples of the results from the experimental fields at Ølve in western Norway. (Assessed marks as in figure 6). Left: Onions from sets 1995: Sat/planted 03.05. Flamed. 22 and 39 days after setting. Assessed 3, 2 and 27 days after 1., 2., and 2. flaming respectively, = “Plant 1, 2, and 3”. Right: Transplanted swedes 1996: Transplanted 12.05.. Flamed 18 and 31 days after transplanting. Assessed 6 and 6 days after 1. and 2. flaming respectively, = “Plant 1 and 2”). Marks for weeds here are 6 days after 2. assessment. (Holmøy, Storeheier and Berge 2000.)

Table 2: Survey of the results of dose-response experiments in selective flaming at Ølve with the following transplanted vegetables: Onions (from sets), leek, autumn cabbage, summer cabbage, cauliflower, broccoli, swedes, red beet, root celery, stalk celery, (Yield and amount of weed and harm /inhabitation measured as in figure 6 and 7)

Plant Vedgetables	Experiments 19995								Experiments 1996							
	Variable ¹⁾	Ha-we ²⁾	Flaming, dose of gas kg ha						Variable ¹⁾	Ha-we ²⁾	Flaming, dose of gas kg/ha					
			0	30	50	70	90	110			0	30	50	70	90	110
Onions	<u>Yield</u>	<u>2,7</u>	1,8	<u>2,2</u>	2,2	3,0	<u>3,5</u>	<u>2,8</u>	Yield	3,4	2,1	2,5	2,6	<u>3,0</u>	2,7	2,8
Leek	Ass.3	4,7	1,3	1,7	2,7	2,6	2,7	1,3	Yield	<u>7,1</u>	5,1	5,5	6,7	6,5	<u>7,0</u>	6,1
A.cabb.	Yield	-	4,1	4,0	4,2	5,3	5,0	4,7	Ass.2	-	5	5	5	5	4,3	3,7
S.cabb.	Ass.3	<u>4,3</u>	2,3	2,3	3,7	4,3	2,7	3,0	Ass.2	-	5	4,8	5	4,8	4,0	2,7
Ca.flow	Ass.2	-	4,7	4,7	4,0	3,7	3,7	3,0	Ass.2	-	5	5	5	3,8	2,7	2,7
Brocco.	Ass.2	-	5,0	5,0	5,0	5,0	5,0	3,8	Ass.2	-	5	5	5	5	4,2	3,5
Swedes	Yield	<u>9,7</u>	4,4	6,7	<u>7,7</u>	6,6	7,0	5,4	<u>Yield</u>	<u>8,0</u>	4,3	5,4	<u>7,9</u>	<u>7,4</u>	<u>7,3</u>	<u>7,1</u>
R.beet	-	-	-	-	-	-	-	-	Yield	3,5	2,0	3,2	4,0	3,3	3,3	4,1
Root.cel	Ass.3	<u>4,0</u>	1,3	2,0	2,7	4,0	3,0	2,3	Yield	<u>2,7</u>	1,8	<u>2,4</u>	2,1	1,8	2,0	1,9
Stal.cel.	Yield	-	5,4	<u>5,7</u>	4,7	4,6	5,3	5,0	-	-	-	-	-	-	-	-
Weed	Ass.2	-	0,3	1,8	3,1	3,5	3,9	4,7	Ass.2	-	0	1,2	3,1	3,7	4,7	<u>5,0</u>

1 Assessment 1, 2 and 3 as in figure 5. Where the yield is not registered the last assessing is given instead. 2) Ha-we (shaded) = hand-weeded plots. Underlined = The same experiments as in fig. 7. Shaded = Max. registered values for flamed plots and hand weeded plots. (Holmøy, Storeheier and Berge 2000)

In table 2 it may also be of interest to compare the registered marks or yield values for hand weeded plots with the marks or yield values for the flamed plots with the highest marks or yield values. (Both shaded) Hand weeding seems to be best in 4 single experiments, flaming in 2, and for 4 experiments the values seemed to be equal. On background of this, and the possibility of having higher values between two of the tried flame doses in stead of exactly on one of them, the conclusion may be that we can not know if there was any general difference between the yield or marks for hand weeding and flaming.

Damages from selective flaming under a shield were more prominent on the herb Peppermint (*Mentha x piperita*) than described above on onions (Table 3). In the first year of growth, when flaming with

inclined and open burners was practicable, the Peppermint came well off with doses up to 50 kg/ha, as we see in table 3. In the second year of growth, however, the Peppermint's ground-covering mode of growing demanded the shielded flame method to be used, with a very bad result. The herb *Melissa officinalis* could not be flamed selectively at all. Other experiments showed selective weeding with the ITF prototype brush to be better for these herbs.

Table 3. Yield (g/m²) for herbs after selective flaming with inclined burners in 1996. (After Storeheier and Netland 1996)

Year and Variable	Plant	Fl. 10 d .aft. tr. pl. Dose kg/ha				Fl. 30 d. aft. tr. pl. Dose kg/ha				Fl.10+30 d. a. tr. Dose kg/ha			
		0	30	50	70	0	30	50	70	0	30	50	70
1996 Yield	<i>Mentha p.</i>	325	269	315	316	281	240	371	335	263	328	372	397
Yield	<i>Melissa o.</i>	236	152	152	89	145	164	125	171	88	243	108	67
1997 Yield	<i>Mentha p.</i>	736	651	446	551	-	-	-	-	-	-	-	-

References

- Holmøy, R., Netland, J. and Balvoll, G. 1993. Band spraying, selective flame weeding and hoeing in late white cabbage. Part 1, and Netland, J., Balvoll, G, and Holmøy, R. Part II, *Acta Horticulturae* 372 1993, pp. 223-243.
- Holmøy, R. and Storeheier, J. K. 1995. Flaming; Fundamental knowledge and practical use in selective weed control. Proceedings 9th EWRS Symposium Budapest 1995 pp. 299-309 and ITF Trykk 25/1995, Dep. of Ag. Eng., Agricultural University of Norway. 11 pp.
- Holmøy, R. 1996. Skjønsmessige karakterer for registrering av biologiske data. (Summary: Assessed marks for registration of biological data. Unregistered manuscript in English) ITF Rapport 78/1996.
- Holmøy, R., Storeheier, K. J. and Berge, L.-T., A. 2000. Studies into the fundamentals of flaming. Will be ready for publication this year.
- Ryan, B., Joiner, B. and Joiner, T. 1985. Minitab Handbook Second Edition. PWS-KENT Publishing Company, Boston, USA
- Storeheier, K. J. 1991. Termisk ugrasbekjempelse (Summary: Thermal weed control). Dr. scient. theses. Dep. of Agricultural Engineering, Agricultural University of Norway. 135 pp
- Storeheier, K. J. 1993 Basic investigations into flaming for weed control. *Acta Horticulturae* 372, 1993, pp. 195-204.
- Storeheier, K. J. og Netland, J 1996 og 1997. Ugrasbekjempelse i urter. Undersøkelser 1996 og 1997. (Summary. Weed control in herbs) Not registered paper 1996 and ITF Trykk 28/1997
- Sutcliffe, J. 1977. Plants and temperature. The Institute of Biology. Studies in biology no 86. Edward Arnold Ltd, London.

Development Of A New Flaming Machine: Experimental Results On Sunflower

Michele Raffaelli*, Andrea Peruzzi* and Paolo Bàrberi**

*D.A.G.A.E. Division Agricultural Machinery and Farm Mechanisation, University of Pisa, via del Borghetto 80, 56124 Pisa, Italy, mraffaelli@agr.unipi.it, aperuzzi@agr.unipi.it.

**Dipartimento di Produzione Vegetale, University of Tuscia, via S. Camillo de Lellis, 01100 Viterbo, Italy, pbarberi@unitus.it.

A new flaming machine was built and tested at the Division of Agricultural Machinery and Farm Mechanisation of the Department of Agronomy and Agro-Ecosystem Management, University of Pisa.

The implement allows to perform both pre-emergence (non selective) and post-emergence (selective) flame weeding. Moreover, it is possible to perform concurrently an inter-row hoeing by means of different tools.

The flaming machine is equipped with 8 rod burners. Each burner has 7 hollow cone nozzles in order to obtain an appropriate flame shape (plate, without reflections). Any couple of burners is placed on a control board and is connected to a 25 kg LPG tank on which a pressure regulator and a manometer are placed. The LPG tanks are placed inside a hopper which contains warm water, thus allowing good heat exchange.

The exhausted gas of the tractor engine are used to heat the water by means of a flexible pipe connected to both the exhaust head and a copper tube placed inside the hopper.

Any couple of burners is connected to an articulated parallelogram in order to maintain the set out adjustments (height and inclination with respect to soil surface) when the flamer is working. These adjustments can be easily performed by means of two levers placed above any single burner, that operate on two screw-lead nut systems. Any couple of burners is also equipped with two valves, two safety taps, a pressure regulator, a manometer and an electronic control system which allows the tractor driver to adjust the LPG feed (high or low levels) and to control if the burners work appropriately directly from his seat. As a matter of fact, three warning lights allow to know if the burners are switched off, or switched on at low or high LPG pressure.

When the flamer is used to perform non selective pre-emergence treatments, the burners are placed parallel to the driving direction and can be covered with metal sheets connected to the frame, in order to increase the efficiency of heat transfer and to avoid problems related to wind and other potential disturbance factors. On the other hand, when the flamer is used post-emergence – such as in the case of the tests that we performed on sunflower – any couple of burners is placed orthogonally with respect to the driving direction in order to form a 25 cm wide flame front which works in the row.

The tools used for inter-row hoeing can be easily connected and disconnected to the flamer. Their presence allows to perform weed control also between the rows where the flame treatment is not effective. Two different tools were used for inter-row hoeing in sunflower: a rolling cultivator and a cultivator with sweeps and goose foot shares.

A field trial was carried out in 1998 and 1999 at The Centro Interdipartimentale di Ricerche Agro-Ambientali “E.Avanzi” of the University of Pisa. The experiment included four different driving speeds (3, 5, 7 and 9 km/h) combined with four LPG pressures (0,1-0,2-0,3-0,4 MPa). Both of the above-mentioned tools for inter-row hoeing were used. Physical weed control treatments (16 flaming x 2 inter-row hoeing combinations) were also compared with a conventional herbicide application and

an untreated control. The experiment was laid out in a completely randomised block design with four replications. At harvest, crop grain yield and weed biomass were determined in each plot.

In 1998, grain yield of the flame- and herbicide treated crop was quite similar, with the exception of flaming when performed at low speed and high pressure, as it had occurred in a previous test carried out in controlled conditions. In 1999, sunflower yield did not significantly differ among weed control treatments. In both years, the unweeded control had a significantly lower grain yield. It is worth noting that with this flamer it is possible, and thus advisable, to perform treatments at a high driving speed (9 km/h) with low LPG consumption (7-12 kg/ha).

In both years, the type of inter-row cultivator did not influence total weed biomass at harvest. In the first year, weed control was higher with herbicide application, while in the second year it did not differ between chemical and mechanical treatments. This can partly be explained by the considerable emergence of volunteer sunflower occurred in 1999.

First results indicate that this new flame machine is very efficient and that is possible to use it successfully in a sunflower crop. However there is a clear need of further improvements of the machines for flame weeding. Moreover a better knowledge of flaming effects on crops and weeds is also needed. Thus it is very important to carry on the research work on this subject.

Electroporation - Can We Control Weed Seeds By The Use Of Electric Pulses Applied In Soil ?

F. Fogelberg

Dept. of Agricultural Engineering, Swedish University of Agricultural Sciences, P.O. Box 66, S-230
53 Alnarp, Sweden;

<mailto:Fredrik.Fogelberg@lt.slu.se>

Today we experience a general demand for pesticide reduction in crop production. This emphasizes the need for new and efficient physical weed control methods. Currently, a method using electroporation to control weed seeds is investigated at the Swedish University of Agricultural Sciences.

Electroporation is a well-known technique to incorporate specific genes into cells. Exposing the cell to high-intensity electric field pulses temporarily destabilize the cell membrane making it highly permeable to exogenous molecules. An increase in the electric field strength will however result in permanent pores in the cell membrane which are lethal to the cell. This effect can then be used as a weed control method.

In the present project weed and crop seeds have been exposed to electric fields of 3-5 kV cm⁻¹. The electric field has been obtained with electric high-voltage pulses with a duration of 1 ms. The seeds have either been treated in peat soil, natural soil or in cuvettes filled with tap-water.

Survey experiments with weed seeds treated in cuvettes showed control effects of 80 -100 %.

Experiments in natural soil obtained from vegetable fields have shown a less pronounced weed control effect compared to the laboratory trials.

About 40 % weed reduction has been achieved in soils with a flora of *Urtica urens*, *Capsella bursa-pastoris* and *Chenopodium album*. In these trials two series of each 50 pulses were given using 3kV cm⁻¹ and 4 kV cm⁻¹.

Crop seeds have also been treated with high-voltage pulses. The results show that the sensitivity to electroporation varies with time. Some common crops such as peas, are controlled to about 100 % while other are less sensitive.

The results of the treatments in natural soil show a potential to use the method for weed control in e.g. vegetable crops. However, additional work must be carried out in order to evaluate the effects of electroporation in field experiments and possible negative impact on soil microflora.

A new methodology for weed control and cereal crop production based on wide span vehicles and precision guidance:

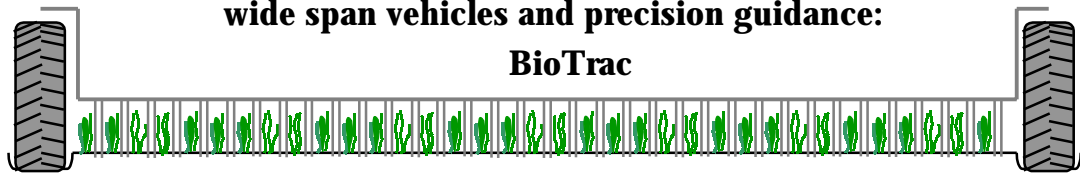

W.C.T. Chamen
BioSystems Group
11 Charles Street, London W1X 7HB

Abstract

A method of crop production is described in which wheel compaction is permanently separated from the cropped area by using wide beds. These beds (>8m wide) are managed by four-wheel drive, four-wheel steer crop spanning vehicles with wheels at their extremities. A range of guidance systems is used to closely control implements attached to these vehicles. The combination of carefully maintained seedbeds, stable vehicles and precision guided implements provides new opportunities in crop production. These opportunities are explored and integrated into a complete crop production methodology, "BioTrac" whose advantages and operation are described.

Introduction

Worldwide, agriculture is under pressure to grow crops more cheaply. At the same time, any improved production methods must take account of the need to preserve the earth's environment.

The costs of existing farming practices are unnecessarily high. Soils are poorly managed. Despite the vast range of new technologies currently deployed, precision is lacking and soils are being increasingly damaged by heavy machines. A complete rethink is needed. By avoiding mechanical soil compaction and introducing row-crop precision, it is possible to cut energy inputs, raise yields and reduce waste. Without wheel compaction, the soil develops a crumb-like structure suitable for accepting seeds, and the stability of the profile improves with time. Presently, our methods of growing crops generally preclude this natural balance, and machines running at random over the soil damage its profile and surface crumb. To restore this structure and destroy weeds the soil is broken up with ploughing and other cultivations. But consolidated soil, when disturbed, tends to form clods and further time and energy has to be expended on creating a seedbed. In dry conditions, this cloddy surface not only prevents the rapid drilling of a new crop, it also prevents weed seeds from germinating at a time when we could control them more easily. These poor conditions deny the chance of working with real precision and cutting out waste - wasted energy, water, chemicals and time. If ideal soil conditions can be maintained and very close precision is brought to all soil and crop management operations, significant cost savings can be achieved.

This paper has two aims:

1. To describe a new crop production methodology based upon wide-span vehicles and precise implement location.
2. To generate discussion and criticism of the system, its potential and its shortcomings.

The crop production system

The system makes use of a number of self-propelled, four-wheel drive, four-wheel steer wide span machines. All of them have similar, hydraulically motorised end units, with the driver's cab at one end and the engine/pump assembly at the other. Implements are positioned using a refinement of the GPS system. This allows the whole pattern of field operations to be marked out precisely and thereafter followed automatically to within ± 20 mm.



Conventional systems use cultivation to achieve three principal objectives:

- to remedy soil compaction
- to deal with residues and
- to manage weeds.

In the system proposed, soil compaction from wheels is eliminated. Without compaction, soil structure is maintained and tillage, when needed, is managed in discrete, closely controlled strips that disturb soil only to the depth of crop sowing.

Cereal residues are dealt with by introducing an integrated approach. Crops are grown with a wider row spacing (around 250 mm) and are harvested with a stripper header or conventional cutterbar. If the crop is stripped, the standing straw may be harvested at a later date and processed to provide a high value feed (a new technology not the subject of this paper). Alternatively, the stripped straw may be rolled onto the soil surface, before, during or after drilling of the new crop (Fig 1.) If the crop is harvested conventionally with a cutterbar, the straw may be laid centrally on the bed and baled, or chopped and spread evenly.

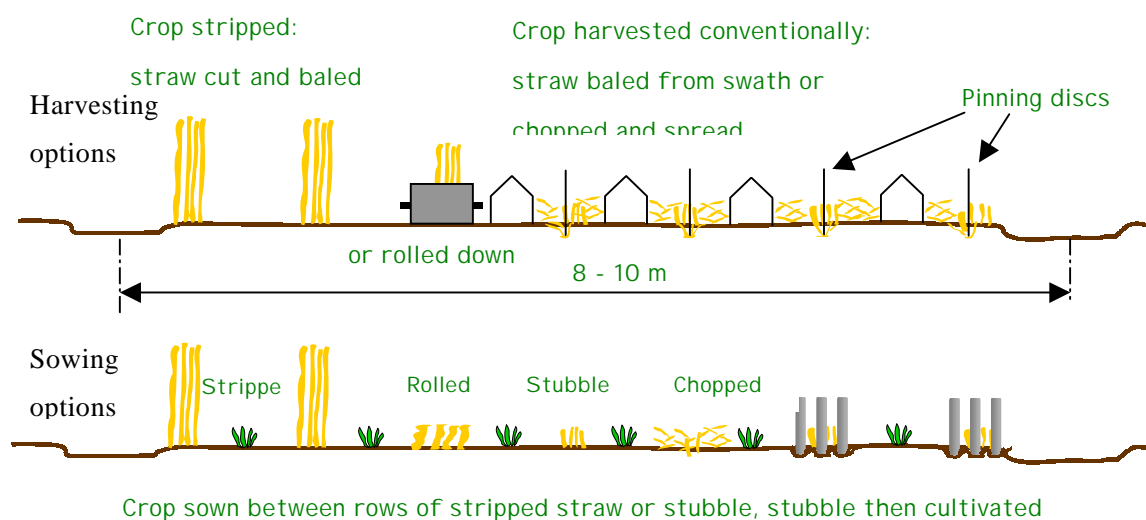

Fig. 1. Illustration of harvesting and crop sowing methods. The space available for inter-row management is around $250 - (2 \times \text{sowing error } (40 \text{ mm}) + 2 \times \text{tillage error } (40 \text{ mm}) + 2 \times \text{clearance } (20 \text{ mm})) = 150 \text{ mm}$

When the straw is spread, it falls to the ground and is deflected by inverted channels and pinned to the ground by vertical discs. The position of the channels is precisely controlled by the guidance system to ensure that those areas left free of straw are the strips into which the new crop will be sown. If straw is left in this way, it can be rolled and used as a

mulch to suppress weeds. In the spring when it has decomposed, inter-row cultivation may be used to speed up the incorporation process and to manage the weeds that have started to grow. Later, this biomass may be managed by cultivation to release nitrogen into the soil, particularly useful in an organic production system.

To manage weeds, other methodologies may be introduced, such as flaming, spraying or new technologies still under development, for example electrolysis, steaming or carbon dioxide laser. The novel aspect of BioTrac is that it can very precisely target only those areas requiring treatment, as shown by example in Fig. 2.

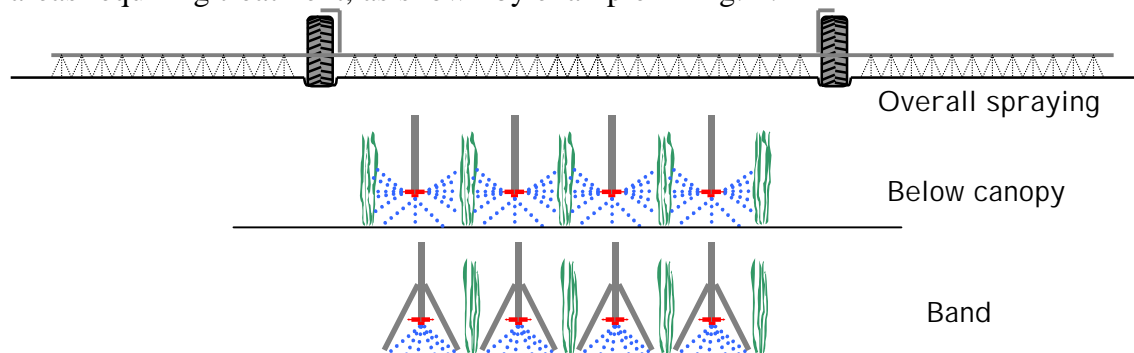

Fig 2. Illustration of overall, below canopy and guarded band spraying with BioTrac

Another option for weed and disease control is to grow a fertility building or cover crop in parallel with the cash crop, for example clover or vetches. In the low compaction and precision regime envisaged, such a crop can be managed to ensure that it does not become too competitive, as has been demonstrated by Wolfe (personal communication) and illustrated in Fig. 3 below. The main problem with this system is the error of ± 20 mm which may not allow close enough containment of the clover by the vertical discs.

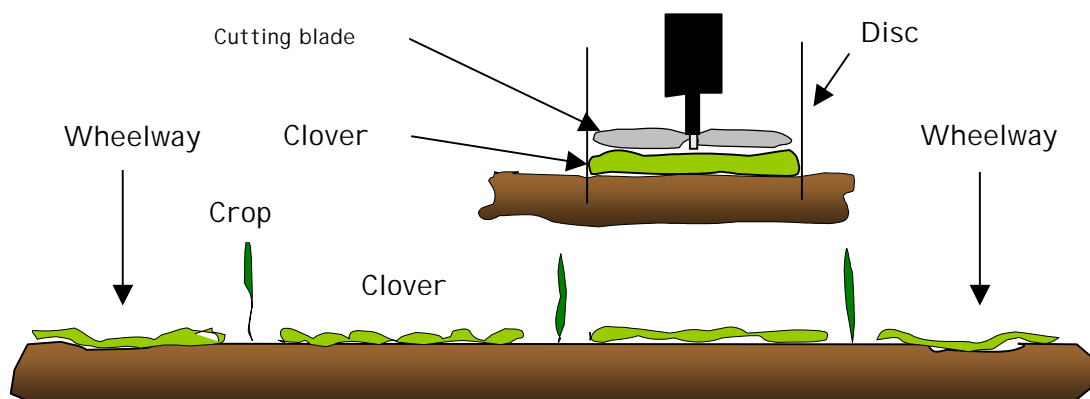

Fig. 3. Inter-cropping with clover which may also be used to protect the permanent wheelways.

In the absence of cover crops, regular inter-row cultivation, carried out until crop canopy closure, effectively produces a seedbed into which next season's crop can be sown. If weed pressure is particularly high, further cultivation immediately after harvest may be undertaken whether stripped or conventionally harvested straw is present, as described above.

Economics

Crucial to the success of any new crop production system is the level of farm profit that it generates. As no farming system of this nature is yet in place, an arable farm model (Audsley, 1981) was used to compare the profitability of BioTrac with a conventional plough-based system and with a minimum tillage system based on discing, all growing a rotation of wheat, oats and oilseed rape. The mathematical model required inputs of labour, machinery, power requirements, soil type and cropping. The database within the model provided information about the days available for different operations and timeliness costs in terms of crop yield. These inputs were then used to calculate optimal solutions in terms of farm profit. Fig 4 shows the baseline results from these comparisons.

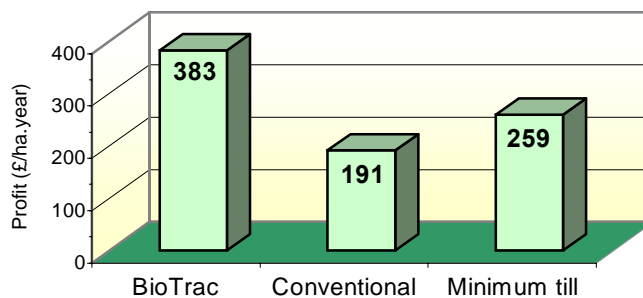

Fig 4. The farm profit from BioTrac and two conventional systems predicted using a mathematical model and based on an arable farm in the UK.

Concluding remarks

A new system of crop production has been presented. This hits at the core of inefficiency within existing methodologies. It cuts out the annual cycle of soil damage and repair and together with close precision, dramatically reduces waste. As a result, flexibility of cropping and weed control are enhanced, better use is made of nutrients and less water is lost unnecessarily from the soil profile. Organic matter is better retained, soil living animals are protected from excessive compaction and cultivation and beneficial gaseous exchange is promoted. Unlike tractor-based systems, matching of bouts is automatically ensured by these vehicles and no implement wheels are placed on the soil.

As with all new technologies, considerable development and refinement will be needed. Presentation of this material is made as a means of promoting criticism and positive feedback. Only in this way can we ensure that the system and designs eventually put in place are able to deliver the advantages envisaged.

Reference

Audsley, E., 1981. An arable farm model to evaluate the commercial viability of new machines or techniques. *J. Agric. Eng. Res.*, 26: 135-149.

Intra-Row Weed Control

J. Bontsema^{*}, C.J. van Asselt[#], G.D. Vermeulen^{*}

^{*}IMAG, P.O.Box 43, 6700 AA, Wageningen, The Netherlands

[#]Wageningen University, Systems and Control Group, Bomenweg 4, 6703 HD Wageningen, The Netherlands

<mailto:j.bontsema@imag.wag-ur.nl>

Abstract

At present weed control in agricultural production is mainly done by using herbicides. In crops which are grown in rows also mechanical weed control by hoeing is performed. However accurate weed control in the row without damaging the crop is hardly known. Only weeder harrows and brushes are used, but with these methods one cannot prevent that the crop is damaged. For certain crops like sugar beet the plants in the row grow on a more or less regular distance from each other, since they are sowed by a precision sowing machine. Also certain vegetables and trees are planted at regular distance in the row. In order to be able to perform mechanical weed control in the row one needs an accurate detection system to locate the plants in the row. Furthermore the mechanical device to remove the weeds between the plants should be able to move very fast in and out of the row.

The presentation is organised as follows:

- A simple model of a row of plants is used to illustrate the signal processing of the detection signal.
- A description of the detection system and the digital signal processor (DSP) is given.
- The mechanical device for the weed control is discussed.
- The results of experiments with the complete system in a laboratory set-up are shown and discussed.
- Finally some conclusions and remarks are given.

References

- Bontsema J., T. Grift, K. Pleijsier (1991). Mechanical weed control in sugar beet growing: the detection of a plant in a row. In Y. Hashimoto and W. Day (Eds.), *Mathematical and Control Applications in Agriculture and Horticulture*, IFAC workshop series, no. 1, Pergamon Press, Oxford, pp. 207-212.
- Gego, A. (1968). Ein Beitrag zum Problem der gesteuerten maschinellen Vereinzelnung von Zuckerruben, Aachen.
- Lempens, P.W.J., J. Bontsema, C.J. van Asselt, G. van Straten (1996). Actuator for use in an agricultural machinery for cultivation of crops growing in rows. *Patent application, no. OA 1004479 Ned.*, (In Dutch).
- Bontsema, J., C.J. van Asselt, P.W.J. Lempens, G. van Straten (1998). Intra-row weed control: a mechatronics approach. In N. Sigrimis and P. Groubos (Eds.), *Control Applications and Ergonomics in Agriculture*, Proceedings 1st IFAC Workshop, Athens, Greece, June 15-17, 1998, pp. 93-97.

Australian Developments in Thermal Weed Control

R.M. Collins

Agriculture Western Australia, Northam, WA 6401

mcollins@agric.wa.gov.au

Thermal weed control is enjoying a resurgence due to its non-chemical mode of action, but widespread adoption is limited by poor thermal efficiency.

Research work, by Ascard in particular, has resulted in dose rates (in kg gas/ha) to achieve weed control. This research has identified some differences due to heat delivery system (flame versus radiant heater) and ways of optimising results from different systems.

Recent interest in thermal weed control in Australia was boosted by a paper at a national gas industry conference in 1995. Tony Atkinson of flame weeding equipment importer GAMECO, of Sydney, postulated a gas demand of 200,000 tonnes of LPG per year if 30% of the total crop area had 35L ha⁻¹ applied (Atkinson 1995). This would be a new market for gas and help develop a larger rural gas demand through establishment of farm based bulk delivery of gas, with the farmer also operating his tractor and vehicles on gas.

Kleenheat Gas and Boral Energy, two gas supply companies have become involved in research and equipment development. Kleenheat Gas imported a H.O.A.F. flame weeder from Holland in 1996 to Western Australia and now has equipment and qualified personnel in each state. The company's policy is to research potential markets before actively selling equipment and gas. Some research has been carried out jointly by research organisations such as Agriculture Western Australia, but mostly it has been with potential customers.

Uses have included:

- ◆ Pre-emergence weed control with carrots
- ◆ Winter grass (*Poa annua*) control in couch turf production
- ◆ Mite control in post harvest flower residue
- ◆ Weed control in grapes
- ◆ Disinfection of broiler poultry houses between successive batches of chickens

Kleenheat is currently leasing H.O.A.F equipment to commercial users for the above uses.

Research work by Agriculture Western Australia (with assistance from Kleenheat Gas) has included:

- ◆ "pasture topping", that is, sterilising grass seeds of annual ryegrass (*Lolium rigidum*) and barley grass (*Hordeum leporinum*) in September – October as the pasture is starting to dry off.
- ◆ Inter-row weed control of annual ryegrass in lupin crops.

The above uses could be made to work reliably but are not yet economically feasible, costing for gas in the order of \$50/ha (see comment by Fawcett, 1997 comparing energy use of thermal compared to chemical weed control methods). Pre sowing 'knock down' and pre-emergence weed control in cereal crops were tried and found to be technically quite difficult due to the variable emergence pattern of the weeds. The pre-emergence use was also found to need very critical timing and would therefore never likely be practiced.

The economic difficulty of thermal weed control can be summarised to two factors:

- Heat is dissipated before it reaches the target plant
- There is difficulty in getting the heat into the plant

Some recent work in Australia and New Zealand has attempted to improve technology in these two areas. The first problem will largely be overcome by better insulation, 'wind proofing' the machine, and the use of exhaust heat from the heater in some way (such as heating incoming air by ducting exhaust gases through a heat exchanger). Jovanovski, of Kleenheat, showed that a 7 km/hr wind speed from different directions could effectively reduce the heat received on the ground under a H.O.A.F flame weeder by a factor of three. A trailing wind gave the greatest heat.

If the heat is considered as either radiant or conductive, the trick must be to prolong the period the plant is exposed to high temperature radiant heat (because of the exponential aspect of radiant heat transmission), and/or utilize a better medium than air to conduct heat where possible. The technical advantage with water is the high heat density (251 KJ/L above 40⁰ C) and good heat transference to the plant through good conduction properties, but it is penalised by the poor heat conducting gradient due to the maximum temperature of 100⁰C.

Several developments in Australasia are using water in different ways:

Waipuna International is a New Zealand company with patents for the use of **hot water** for weed control and has through the 1990's developed a world wide business of supplying leased equipment for urban weed control. The appeal has been the low risk association with water use, albeit hot, but considerable quantities of water are required (about 20-25000 L/ha⁻¹). This may be economic for urban weed control as treatment costs have been only slightly higher than the cost of chemical herbicides, but are grossly uneconomic, and impractical, for horticultural and agricultural uses. In sandy soil, hot water movement into the soil will kill guildford grass (*Romulea rosea*) bulbs (an onion like plant), and possibly some seeds (although dry seeds will withstand temperatures up to 120⁰C, according to Levitt). Aqua Heat Technology of the US claimed the cost of hot water weed control in Florida citrus groves with their technology in 1994 was estimated at US\$15-20 acre⁻¹, but their brochure did not quote water rates.

Steam is another option, having the advantage of a greater heat content than boiling water due the latent heat of vaporisation, plus a little bit more if superheated. At 100⁰C it has 2508kj kg⁻¹, but occupies 1673 litres kg⁻¹, compared to 1 litre kg⁻¹ for water, so as heat content per litre, 100⁰C steam has 1.5kj. There is difficulty in getting the steam to condense on the plant to make use of the latent heat, requiring trailing covers over the weeds. The apparent advantages of steam are difficult to capture. Maybe the steam could be charged to attract it to the plant, as is done with ultra-low volume spraying. Work in NZ (Collins, 1994, unpublished) showed that 3,000 L ha⁻¹ could give a similar effect to a light paraquat application (ie, producing a 'knockdown' from which the pasture soon recovered) on a perennial ryegrass-white clover pasture. Best results were achieved with a mixture of steam and water, ensuring the hottest water delivery temperature, with the steam also ensuring good plant surface coverage. It is possible to generate the steam in the flame, and there is a product being developed on this principle by Atarus, a subsidiary of Boral Energy (now named Origin Energy). It has been experimenting with the principle to improve the heat delivery and avoid residue ignition. Each burner uses 14 L/hour of water and results from weed control in grapes is very encouraging. This development is patented and is near release onto the commercial market.

An idea that both Waipuna and ThermeKill (of Perth, Western Australia) are working on, is **hot foam**. Hot foam has an advantage over hot water in that much less water is used. Possibly the heat can be held against the weed for a longer period, although initial measurements by the author showed results no better than water. Waipuna figures show that water use is reduced to between 1/6 to 1/20th of the amount needed with the hot water system. Foam has the possibility of an enhanced kill with the foaming agent acting as a 'cuticle-stripper', an action likely to be increased by the temperature. Foaming agents need to be biodegradable yet heat stable in formulation and foaming characteristics. Quantities can be quite low, for example, 0.025% of a commercial foam marking agent has given good results.

Waipuna have recently released through-out Australia a '**domestic market**' '**steam weeder**'. A garden hose supplies water and a electric supply lead capable of taking 10 amps supplies power for the heater. One tested by the author put out 18 L/hr of water at 93⁰C. Action is slow, but ideal for proximity to non-weed plants and has no fire risk compared to a gas burner

The inspiration for the use of **hot air** was the possibility of a more efficient use of energy (through recycling heat), a safer appliance, and no water to collect and carry. It has been found that the most effective plant damage is done where there is some part of the machine radiating heat and the air must be directed to the base of the plant (Tindall, pers com). Where hot air is recycled, there must be a

heat exchanger, as too much exhaust added to the burner air will lead to poor combustion because of oxygen depletion. Waipuna is one company developing this system.

This author believes that some combination of radiant heat, water or steam as a 'scalding' substance, and a cuticle stripper/foaming agent will bring a break-through in thermal weed control technology development.

Ascard, J. (1997). Flame Weeding: effects of fuel pressure and tandem burners. *Weed Research* 37, 77-86

Ascard, J. (1998). Comparison of flaming and infrared radiation techniques for thermal weed control. *Weed Research* 38, 69-76

Atkinson, A. (1995). 'Flame cultivation, not such a new idea'. GAMECO (NSW) Pty Ltd, Sydney, pp 7

Fawcett, R. (1997). What are we burning down on the farm? *Farm Journal*, March, ZE-15

Levitt, J. (1980) 'Responses of plants to environmental stresses.' (Academic Press, New York).

Tindall, D., Managing Director, Waipuna International.

Acknowledgments

I would like to thank Dr David. Bowran (AGWEST, Northam) and Professor Steve Powles, (WAHRI, UWA, Perth), and Zlatko Jovanovski (Engineer, Kleenheat Gas, Perth) for their help and encouragement.

Also thanks to Larry Lamb of Atarus, Max Scott of ThermeKill and Dennis Tindall of Waipuna International, for information and photographs.

Precision Physical Weed Control

R.G. Northway and J.N. Tullberg
Crop Technology Group,
School of Agriculture and Horticulture,
University of Queensland Gatton, Gatton 4343 Australia
northway@mailbox.uq.edu.au , j.tullberg@mailbox.uq.edu.au

Introduction

The last two years has seen significant adoption of controlled traffic farming in northern Australia, and an acceptance by informed observers that this system will provide improved productivity and sustainability while reducing costs.

Because controlled traffic layout has a major effect on runoff, which in turn drives the major erosion events, this has generated a demand for guidance systems operating at a greater level of precision than that achieved in commercial “precision farming” systems. The best known of these, Agsystems ‘Beeline’ has demonstrated the ability to control a tractor to within 20 mm in the field practice. Other row/furrow following systems developed largely for use in intensive row cropping such as the Rimik ‘Autotrack’ and the Case vision guidance system also claim row-following precision of the same order.

These systems alone or in combination will allow a field machine to be controlled reliably and repeatably within 20 mm or less. This provides clear and immediate opportunities in terms of physical weed control and crop residue management. The DGPS based systems which permit this precision on a year to year basis, rather than just within crop, appear to allow significantly greater benefits in the long term by allowing precision multiple strip cropping where all operations are undertaken in modular widths.

This paper reports the preliminary results of tests to investigate the level of precision relevant to physical weed control.

Methods and Materials

A mechanical precision guidance system has been devised, based on an 8 m, 250 mm section universal steel beam, fitted with a drive system carriage. This unit permits precision control of inter-row tillage units in relation to permanent reference points.

This unit has been used to move different tillage tools through rows of young sorghum at an angle of approximately 4 degrees, providing a sensitive method of controlling the mean row center line – inter-row tillage tool and assessing crop impact. In the current work this was achieved by measuring individual dry matter, two weeks after treatment on 4 replicates. Rainfall was excluded from the treatment area by the use of movable clear plastic covered structures.

The precision guidance system, structures and all other aspects of the work were compatible with a 3m controlled traffic environment, which ensured a fine tilth, and prevented larger aggregates from interfering with planting and tillage operations.

Preliminary Results

The first objective of this work was to assess the minimum distance between an interrow tillage tool and a crop row that would not significantly affect yield, while achieving effective weed control. Data from this preliminary trial indicated that a sweep can work at a distance approximately 20mm from the crop row before any reduction in dry matter occurs.

These results also suggest significant differences in the effects of the two sweep types on sorghum plant dry matter production two weeks after treatment. The original, low-profile sweep had a more severe effect on dry matter production than the modified, “beet knife” type sweep, and apparently damaged plants from at a greater distance from the crop row than the modified sweep.

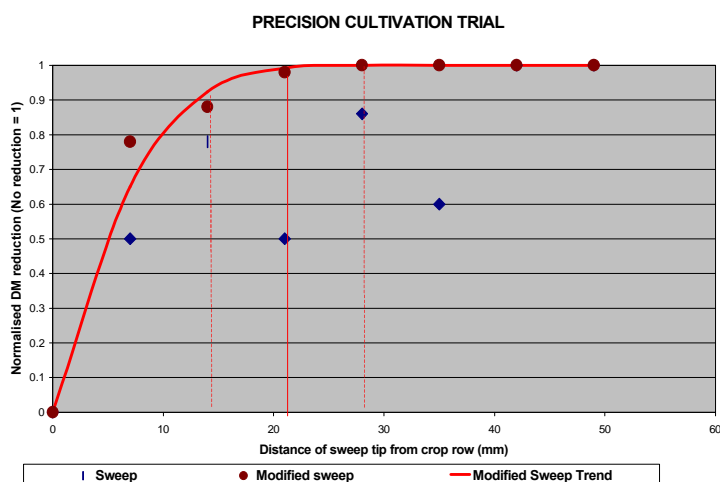

PAIRED COMPARISON T TEST - TRANSVERSE OPEN FIELD TRIAL

Variables	N	Means	Std. Deviation	Std Error	T	Prob> T
W	25	37.2760000	13.2447562			
N	25	27.0520000	14.5162874			
Diff	25	10.2240000	21.7461161	4.3492232	2.3507646	0.0273

Future Plans

Differences observed in these tests appeared to be important, but they were marginal in terms of statistical difference. Further experiments will assess the interaction of horizontal distance and depth at varying soil moistures, and attempt to define physical weed control tool design parameters.

Observation, rather than hard data, suggests that interrow weed control units can make physical contact with the crop row, without inflicting significant damage. This capacity should provide effective weed control, while soil deflection into the row might also provide useful intrarow weed control.

Applied Ecological Principles: Intercropping As A Weed Management Component

Daniel T. Baumann¹, Lammert Bastiaans² and Martin J. Kropff²

¹Swiss Federal Research Station for Fruit-Growing, Viticulture and Horticulture,
P.O. Box 185, CH-8820 Wädenswil, Switzerland

²Group of Crop and Weed Ecology, Wageningen University and Research Centre
P.O. Box 430, NL-6700 AK Wageningen, The Netherlands

<mailto:daniel.baumann@faw.admin.ch>

Introduction

Intercropping in field vegetable production has many advantages, such as reduced pest and disease pressure, decrease of weed infestations, soil erosion, fertiliser and pesticide requirements and soil compaction while enhancing organic matter, water infiltration, moisture and nutrient retention (eg Horwith, 1985 and others). On the other hand, intercrops, like weeds, interfere with the main crop, reducing yield through competition for light, water and nutrients. Using a companion cash crop as a method was suggested to improve the weed suppression of vegetable crops with weak competitive ability (Baumann *et al.*, 2000). It was hypothesised that the suppressive ability of a leek cropping system against weeds could be improved by the introduction of celery as an intercrop, in order to increase light interception and to accelerate the closure of the crop canopy.

Material and methods

Greenhouse and field experiments to study the intra- and interspecific interactions in a leek-celery intercrop system with additional weed suppression were carried out from 1996 to 1998. The crop canopies of pure stands and mixtures of leek and celery were characterised and their effects on the biomass and seed production of weeds, and common groundsel (*Senecio vulgaris* L.) in particular were assessed. Moreover, the interference among the crops within the mixture was analysed using descriptive competition models (Spitters, 1983).

Results and discussion

As a result of a significantly earlier and faster canopy light interception, the critical period for weed competition in the intercrop was considerably shorter compared to leek pure stand (Fig. 1). The relative soil cover of weeds was reduced by 41%, the biomass of *S. vulgaris*, which was planted 20 days after crop establishment, was reduced by 58% and the number of seedlings which emerged as offspring was reduced by 98% in the intercrop compared to pure stand of leek. Analysis of the resource allocation of *S. vulgaris* showed that the relative reduction of the reproductive potential was 16% higher than the relative reduction in biomass under increased light competition. The relative yield total of the intercrop exceeded that of the pure stands by 10%, due to an optimised exploitation of the resources. Resource complementarity was, however, only found for light and not for nutrients. Celery appeared to be more competitive than leek, resulting in quality reduction for the latter if plant densities were too high.

Conclusions

It is concluded that intercropping can be used as a tool to improve competitive ability of a canopy with weak suppressive characteristics (Baumann *et al.*, 2000). Interactions between crops and weeds need to be studied in more detail and the use of an ecophysiological crop growth model is suggested

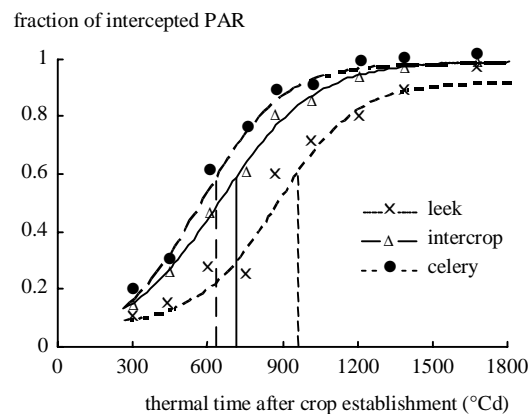

Figure 1. Fraction of intercepted photosynthetically active radiation (PAR) by leek, celery and intercrop and end of critical period (vertical lines) in these crop stands.

to optimise the intercrop mixtures with respect to yield, quality and suppressive ability of the crops against weeds.

References

- Baumann, D.T., Kropff, M.J., and Bastiaans, L. (2000). Intercropping leeks to suppress weeds. *Weed Research* 40 (4), 359-374.
- Horwith, B. (1985). A role for intercropping in modern agriculture. *Bioscience* 35, 286-291.
- Spitters, C.J.T. (1983). An alternative approach to the analysis of mixed cropping experiments, Part I and II. *Netherlands Journal of Agricultural Science* 31, 1-11, 143-155.

Report of a roundtable discussion on:
Assessment methods for weed control and crop damage
&
Risks perception and adoption of mechanical weed control in practice

Held at the 4th EWRS workshop on physical weed control
Elspeet, The Netherlands, 20-22 March 2000.

Participants' research targets

The desired methods for assessment of weed control and crop damage will largely depend on the research aim. Therefore, the participants were asked to classify their research targets into the categories listed below (multiple classes possible).

1. Compare machines: effectiveness of single treatments, depending on crop type, crop growth stage, weed species, soil, implement adjustments, weather, ... (13 participants)
2. Fundamental studies on the underlying mechanisms of competition, weed population dynamics, energy requirement for thermal control by hot air, microwave and infrared radiation, developing the harrowing selectivity concept, plant response to simulated mechanical damage, damaging mechanism of mechanical weeders, ... (8 participants)
3. Optimise the weed control strategy: tactical and operational decisions within a cropping season, farming system. (3 participants)
4. Facilitate knowledge exchange and training with farmers and study groups, introducing concepts and technology, creating inspiring examples. (3 participants)
5. Systems modelling to specify the required technology to fill "weak spots" of a "chain", analyse risk & cost, a-priori agronomic evaluation of government policy on herbicides. (3 participants)
6. Compare overall efficacy of multiple weed treatments: compare chemical with mechanical, no-till with plough, cover crop with "conventional" cropping systems. (1 participant)

Although most participants dealt with assessments on single treatments (1, 2), there was a general desire to work more on the "systems" level (3, 5) in the future.

Assessment methods used

As yet, there are no standardised methods for assessing physical damage to crop and weeds. Methods used by participants include:

1. Plant dry matter 2 weeks after treatment
2. Countings. Mostly done using 0.25 m² quadrates (50 x 50 cm) at one or more random locations per plot. Sometimes only intra-row weeds (e.g. between hoe shares) are counted using narrower and longer frames (e.g. 10 cm x 2.5 m). Especially if several categories are distinguished (dicot/monocot, perennial/annual, or 4-5 main species), the number of weeds per group should be sufficient to allow statistically sound analysis. Instead of using the number of plants on a fixed area, one could also measure the size of the area (e.g. row

length) containing a certain minimum number of weeds. This is one way of preventing unreliable results due to low weed numbers.

3. Leaf temperature change directly after cultivation, using an infrared laser: limited transpiration increases leaf surface temperature relative to the ambient air temperature. (Jeff Tullberg, one year experience) Unfortunately, the link between leaf temperature change and plant damage is not clear.
4. Qualitative weed and crop damage assessment on a 1-5 scale, followed by quantitative assessments (countings) on representative areas (Reidar Holmoy). Guidelines are needed to maintain the same scale (between experiments) and minimise observer-induced bias.
5. Automatic assessment of spectral reflectance or the percentage leaf-covered surface (by image processing) could provide a means for making visual score methods more objective. Problems: reflectance influenced by soil conditions, only "green" detected, species discrimination (crop /weed) is still difficult. Possible solution: measurements in weed free and crop free conditions.

Plot selection:

Many participants use marked counting plots to prevent bias from within-plot heterogeneity. Some participants deliberately choose the location of counting plots within a treatment plot, in order to prevent extreme or non-representative spots. Others advocate using random counting plot positions, to prevent observer bias.

To prevent bias by steering error, counting plots should be in the middle part of the plot and have sufficient length (e.g. by splitting up), so there are also parts without steering error. In most cases, 4 repetitions in blocks are used, and some use one extra block in case things go wrong.

Qualitative versus quantitative assessment:

Qualitative assessments require less time, represent whole plots (no effect of spatial heterogeneity within plots) and are useful for farmers. Quantitative methods are believed to be more objective (constant and reliable scales). Although most researchers prefer quantitative methods, it was questioned whether the advantage of objective counts, weights, etc. is outbalanced by the advantages of qualitative methods. How objective are the qualitative methods, and how can objectivity be improved? Standards and scales need to be developed to reduce observer bias and improve comparability between sites and years.

Correlation between immediate damage and final weed control and crop yield loss:

The meaning of measurements depends on their timing. For example, weed counting directly after harrowing reflects the covering performance of the implement. If this assessment were done one week later, it represents the joint effect of the covering performance of harrowing and the recovery of the plants. Direct damage measurements should have predictive value for the final damage parameter (e.g. crop yield, weed seed production, but their interrelationship may be influenced by competition, weather, etc. More research into these relationships is needed.

Nevertheless, evaluation of direct damage is useful to guide decisions while manipulation is still possible (during harrowing). One could try to standardise the timing of measurements

(e.g. Maryse Leblanc: at 10-leaf stage and in full-grown maize). In addition, the relevance of the assessment (e.g. number of weeds and or biomass) in relation to the decision to be made could be reconsidered. What is relevant: how many weeds are left in total, or the number of weeds that (will?) have to be hand-weeded, or the size of the 10 biggest weeds per surface area that still can be controlled: when is the next treatment necessary?

In this respect, the assessment of small but relevant differences in crop yield requires special attention. How can plant loss and soil-coverage directly after cultivation and/or after ... days be related to yield loss?

Risks perception and adoption of mechanical weed control in practise

In this part of the session we discussed knowledge transfer and co-operation between researchers and farmers and the kind and reality and perception of risks involved in mechanical weed control.

The way a farmer deals with risks depends on his experience. The reality and relevance of particular risks are dependent on the situation (e.g. frost risk). Furthermore, adopting mechanical weed control is not only a change of techniques but adoption of a whole different system in which crop-weed competition and preventive measures require more consideration. The control of remaining weeds and the thresholds with respect to weed seed production are important issues on which researchers could give important information.

It is experienced that farmer perceptions are often shaped by "bad rumours" that influence their expectations of mechanical techniques. The process of perception change involves social (group discussions, seeing things work on a farm of a widely respected colleague), psychological and rational aspects. Training selected farmers in a region appears to be a good strategy to convince other farmers. Rational calculations about economic aspects (subsidised switch to organic production, product prices) play an important role in the final decision. It is important to be honest and realistic. Because using mechanical weed control is a learning process, the first year is always difficult. Once farmers have accepted the mechanical technique they often appear to have a certain perception of how to handle it. For example, they are generally tend to prevent all visible crop damage and plant loss, whereas more damage could be accepted to improve weed control.

Suggestions to improve co-operation between farmers and researchers include development of decision support systems, creating forums for expert knowledge (e.g. by discussions on the Internet) and close co-operation with expert farmers. Finally, practical problems should be solved in the systems context. In addition, explicit survey and analysis of farmer perceptions, knowledge (availability and quality, communication) and acting could help us to plan research and increase its impact and relevance for farmers.

Rommie van der Weide (R.Y.van.der.Weide@PPO.DLO.NL)

Dirk Kurstjens (Dirk.Kurstjens@user.AenF.WAU.NL)